

# *Compact Conference Package*

---

## **Operating Instructions**

Before operating the unit, please read this manual thoroughly and retain it for future reference.

**PCS-1600/1600P**



**MEMORY STICK™**

## **Owner's Record**

The model and the serial numbers are located at the bottom. Record the serial number in the space provided below. Refer to these numbers whenever you call upon your Sony dealer regarding this product.

Model No. PCS-1600/1600P

Serial No. \_\_\_\_\_

## **WARNING**

**To prevent fire or shock hazard, do not expose the unit to rain or moisture.**

**To avoid electrical shock, do not open the cabinet. Refer servicing to qualified personnel only.**

### **For the customers in the USA**

This device complies with Part 15 of the FCC Rules.

Operation is subject to the following two conditions: (1) This device may not cause harmful interference, and (2) this device must accept any interference received, including interference that may cause undesired operation.

This equipment has been tested and found to comply with the limits for a Class A digital device, pursuant to Part 15 of the FCC Rules. These limits are designed to provide reasonable protection against harmful interference

when the equipment is operated in a commercial environment. This equipment generates, uses and can radiate radio frequency energy and, if not installed and used in accordance with the instruction manual, may cause harmful interference to radio communications. Operation of this equipment in a residential area is likely to cause harmful interference in which case the user will be required to correct the interference at his own expense.

You are cautioned that any changes or modifications not expressly approved in this manual could void your authority to operate this equipment.

The shielded interface cable recommended in this manual must be used with this equipment in order to comply with the limits for a computing device pursuant to Subpart B of Part 15 of FCC Rules.

### **IMPORTANT INSTRUCTION TO USERS**

1. This equipment complies with Part 68 of the FCC rules. On the rear of this equipment is a label that contains, among other information, the FCC registration number for this equipment. If requested, this information must be provided to the telephone company.
2. If the terminal equipment causes harm to the telephone network, the telephone company will notify you in advance that temporary discontinuance of service may be required. But if advance notice is not practical, the telephone company will notify the customer as

soon as possible. Also, you will be advised of your right to file a complaint with the FCC if you believe it is necessary.

3. The telephone company may make changes in its facilities, equipment, operations or procedures that could affect the operation of the equipment. If this happens the telephone company will provide advance notice in order for you to make necessary modifications to maintain uninterrupted service.
4. If trouble is experienced with this equipment for repair or warranty information, please contact Sony Business Information Center ☎ 1-800-686-7669. If the equipment is causing harm to the telephone network, the telephone company may request that you disconnect the equipment until the problem is resolved.
5. Connection to party line service is subject to state tariffs. Contact the state public utility commission, public service commission or corporation commission for information.
6. If your home has specially wired alarm equipment connected to the telephone line, ensure the installation of this equipment does not disable your alarm equipment. If you have questions about what will disable alarm equipment, consult your telephone company or a qualified installer.
7. Plugs and jacks used to connect this equipment to the premises wiring and telephone network must comply

with the applicable FCC Part 68 rules and requirements adopted by the ACTA. Compliant telephone cords and modular plugs are provided with this product. They are designed to be connected to compatible modular jacks that are also compliant.

8. The following information is required when the customer orders service from the local telephone company.
  - Applicable certification jack  
Universal Order Codes “USOC”:  
RJ45
  - Facility Interface Codes “FIC”:  
02IS5
  - Service Order Codes “SOC”:  
6.0N

### **For the Customers in EU countries**



Hereby, Sony Corporation, declares that this PCS-P160P is in compliance with the essential requirements and other relevant provisions of Directive 1999/5/EC.

The PCS-P160P is intended to be connected to the ISDN using basic rate access interface in accordance with CTR 3 protocol.

This manual focuses on using ISDN lines to conduct a videoconference, but it also covers non-ISDN lines. If you use ISDN lines, consult your Sony dealer for more information.

- The ISDN service may not be available in some areas.

## Voor de klanten in Nederland

Dit apparaat bevat een vast ingebouwde batterij die niet vervangen hoeft te worden tijdens de levensduur van het apparaat.

Raadpleeg uw leverancier indien de batterij toch vervangen moet worden. De batterij mag alleen vervangen worden door vakbekwaam servicepersoneel.

Gooi de batterij niet weg maar lever deze in als klein chemisch afval (KCA).

Lever het apparaat aan het einde van de levensduur in voor recycling, de batterij zal dan op correcte wijze verwerkt worden.



If you dispose the unit, consult your nearest Sony Service Center. The built-in battery must be treated as a chemical waste.

## For the customers in Canada

This Class A digital apparatus complies with Canadian ICES-003.

**NOTICE:** The Industry Canada label identifies certified equipment. This certification means that the equipment meets certain telecommunications network protective, operational and safety requirements as prescribed in the appropriate Terminal Equipment Technical Requirements document (s).

The Department does not guarantee the equipment will operate to the user's satisfaction.

Before installing this equipment, users should ensure that it is permissible to be connected to the facilities of the local telecommunications company. The equipment must also be installed using an acceptable method of connection. The customer should be aware that compliance with the above conditions may not prevent degradation of service in some situations.

Repairs to certified equipment should be made by an authorized Canadian maintenance facility designated by the supplier. Any repairs or alterations made by the user to this equipment, or equipment malfunctions, may give the telecommunications company cause to request the user to disconnect the equipment.

Users should ensure for their own protection that the electrical ground connections of the power utility, telephone lines and internal metallic water pipe system, if present, are connected together. This precaution may be particularly important in rural areas.

**Caution:** Users should not attempt to make such connections themselves, but should contact the appropriate electric inspection authority, or electrician, as appropriate.

# Table of Contents

Precautions .....	9
-------------------	---

## Chapter 1

### Preparation

<b>Features .....</b>	<b>11</b>
<b>System Configuration .....</b>	<b>13</b>
Basic System Equipment .....	13
Options .....	14
<b>Basic System Connection .....</b>	<b>16</b>
<b>Preparing the System .....</b>	<b>17</b>
Inserting Batteries into the Remote Commander .....	17
Preparing the TV Monitor .....	18
Setting the Initial Volume Level on the TV .....	19
Installing the Compact Processor .....	20
<b>Turning the System On/Off .....</b>	<b>21</b>
Turning On .....	21
When the Compact Processor is turned on for the first time .....	22
Setting the System (Compact Conference Package) to be on Standby .....	27
On the Help Menu .....	28
On the Version And Option Indications .....	28
Turning Off .....	29
<b>How to Operate the Menu .....</b>	<b>30</b>
Switching the Menu Not in Communication .....	30
Switching the Menu in Communication .....	35
Operating the Menu .....	38
Turning Off the Indicators displayed on the screen .....	39
Entering Characters .....	39

## Chapter 2

### Basic Operation During a Meeting

<b>Calling a Remote Party .....</b>	<b>41</b>
Calling an Unregistered Remote Party .....	42
Calling a Registered Remote Party .....	47
<b>Receiving a Call .....</b>	<b>49</b>
Setting the Answer Mode .....	49
Answering Calls in Auto Answer Mode .....	49

# Table of Contents

---

Answering Calls in Manual Answer Mode .....	50
<b>Checking the Connection Status .....</b>	<b>52</b>
<b>Adjusting the Sound .....</b>	<b>54</b>
Adjusting the Volume .....	54
Muting Local Conversations – Mute Function .....	54
Synchronizing Voice and Motion	
– Lip Synchronization .....	54
On the Echo canceler .....	55
<b>Adjusting the Camera .....</b>	<b>56</b>
Adjusting the Camera Angle and Zoom .....	57
Adjusting Focus and Brightness .....	58
Presetting Angle and Zoom Settings .....	59
Tracking a Subject Automatically	
— Automatic Target Tracking Function .....	61
<b>Selecting the Picture and Sound .....</b>	<b>64</b>
<b>Monitoring Yourself in the Inset Window .....</b>	<b>65</b>
<b>Displaying a Still Picture .....</b>	<b>66</b>
Displaying a Still Picture Stored in the	
“Memory Stick” .....	66
Notes on a “Memory Stick” .....	68
Clearing the Still Picture From the Screen .....	69
Saving a still image .....	69
<b>Sending Still Pictures .....</b>	<b>70</b>
Sending One Still Picture .....	70
Sending Still Pictures Continuously .....	71
Sending Still Pictures of the Object Camera .....	71
Sending a Still Picture Stored in the	
“Memory Stick” .....	72
Clearing the Still Picture From the Screen .....	72
<b>Saving a Still Picture Into the “Memory Stick” .....</b>	<b>73</b>
Saving with the “Memory Stick” menu .....	74
<b>Sending the Dial Tone to the Remote Party .....</b>	<b>75</b>
<b>Ending a Meeting .....</b>	<b>76</b>

---

## Chapter 3

### Advanced Operation

<b>Connecting With an MCU .....</b>	<b>77</b>
<b>Voice Meeting .....</b>	<b>80</b>

---

## Chapter 4

### Registration and Setup

<b>Registering a Remote Party .....</b>	<b>81</b>
Making an Entry .....	82
Modifying an Entry .....	86
Deleting Registered Entries .....	87
Duplicating the Setting of the Phone Book Menu .....	87
Notes on Registration .....	88
<b>Registering Local Information .....</b>	<b>89</b>
Setting Up the ISDN Setup Menu .....	89
<b>SPID Registration for Customers in the USA .....</b>	<b>92</b>
<b>Menu Items in the Setup Menu .....</b>	<b>100</b>
Dial Setup Menu .....	100
Answer Setup Menu .....	105
Multipoint Setup Menu .....	107
Audio Setup Menu .....	108
General Setup Menu .....	109
Administrator Setup Menu .....	112
ISDN Setup Menu .....	113
LAN Setup Menu .....	113
Machine Information Menu .....	116

---

## Chapter 5

### Meetings With Optional Equipment

<b>Installing the Optional Board .....</b>	<b>117</b>
Using Three ISDN Lines .....	118
Using the V.35 Interface .....	118
<b>Upgrading the Software .....</b>	<b>119</b>
<b>Connection using a LAN .....</b>	<b>120</b>
<b>Using Dual Monitors .....</b>	<b>121</b>
<b>Using Optional Microphones .....</b>	<b>122</b>
<b>Recording the Meeting Audio .....</b>	<b>123</b>
<b>Using the External Equipment .....</b>	<b>124</b>
Connecting External Video Equipment for Input .....	124
Connecting External Equipment for Output .....	125
<b>Holding a T.120 Data Conference .....</b>	<b>126</b>
Connecting With a PC .....	126
Setting Up the Compact Processor .....	127

# Table of Contents

---

Connecting with NetMeeting .....	128
<b>Accessing the Unit Using an External Control .....</b>	<b>129</b>
Using a Web Browser .....	129
Via the Telnet .....	129
Via the AUX CONTROL Connector .....	129

---

## **Chapter 6**

### **Meetings With the Multipoint Function**

<b>Features .....</b>	<b>130</b>
<b>Starting a Point to Multi-Point Meeting .....</b>	<b>131</b>
Registering a Multipoint Conference in the Multipoint connection list .....	131
Calling a registered remote party .....	134
Receiving Calls .....	138
Notes on Point to Multi-Point Meetings .....	138
<b>Operating Chair Controls .....</b>	<b>139</b>
Switching the Broadcast Mode .....	139
Selecting the Picture to be Broadcast .....	140
Verifying the Picture Shot by the Local Camera .....	141
Receiving the Broadcast Request .....	141
<b>Ending a Point to Multi-Point Meeting .....</b>	<b>142</b>
<b>Notes on Secondary Terminals .....</b>	<b>143</b>
<b>The Attribute .....</b>	<b>145</b>

---

## **Appendix**

<b>Location and Function of Parts and Controls .....</b>	<b>147</b>
<b>On Screen Messages .....</b>	<b>155</b>
<b>Troubleshooting .....</b>	<b>158</b>
<b>Specifications .....</b>	<b>160</b>
<b>Videomeeting Room Layout .....</b>	<b>167</b>
<b>Glossary .....</b>	<b>170</b>

## On Safety

### **Power supply**

- Before operating the Compact Conference Package, make sure the operating voltage of the unit is identical with that of your local power supply. The Remote Commander operates on two size AA (R6) batteries.
- Do not unnaturally bend or crimp the power cord, and do not place heavy objects on it. Damage to the cord may result in fire or electric shock.
- To remove the power cord from an AC outlet, pull out the plug. (Do not pull out the cord itself.)

### **Do not disassemble the system**

Do not open or disassemble the cabinets of the system. Electric shock may result if you touch the inside of the cabinets.

### **Do not put foreign objects into the system**

Avoid having metallic or flammable object, liquid, or foreign matters fall into the cabinets of the system. Otherwise a malfunction may result.

### **In case of trouble**

In case of trouble such as smoke, odd smell, or noise, turn off all units of the system. Disconnect all the power cords and connecting cords. Then contact the place of purchase or an authorized Sony representative.

### **ISDN**

Never install telephone wiring during a lightning storm.

Never install telephone jacks in wet locations unless the jack is specifically designed for wet locations.

Never touch uninsulated telephone wires or terminals unless the telephone line has been disconnected at the network interface.

Use caution when installing or modifying telephone lines.

Avoid using a telephone (other than a cordless type) during an electrical storm. There may be a remote risk of electric shock from lightning.

Do not use the telephone to report a gas leak in the vicinity of the leak.

# Precautions

---

## On Handling

### Installation/storage

Do not expose the system to:

- Extremely low or high temperatures.
- Damp or dusty room.
- Strong vibration.
- Near devices which generate strong magnetic fields.
- Near devices (such as radios) which transmit strong radio wave.
- Noisy place.

### Cleaning

Wipe the cabinets and panels with a dry and soft cloth. If the stain is serious, slightly moisten the cloth with mild detergent. Afterward, use a dry cloth to wipe it. Do not use solvents such as thinner, benzine, alcohol, as they may damage the finish of the cabinets.

# *Preparation*

## Features

The PCS-1600/1600P Compact Conference Package can connect a remote party via an ISDN (Integrated Services Digital Network) line. It sends and receives images and sound, allowing you to have virtual face-to-face meetings with people in other cities or countries.

The system accommodates up to three participants in one location. However, you can add the optional PCS-A300 Microphones for additional participants.

- If you upgrade the Compact Conference Package using the PCS-UC160 Upgrade Kit and PCS-I160 BRI Board, you can use the Compact Conference Package as the MCU (Multipoint Control Unit) to hold a point to multi-point meeting among four terminals.
- You can install an optional interface board for connection with V.35 interface or with 6B channels.
- If you upgrade the Compact Conference Package using the PCS-UC161 Upgrade Kit, you can connect a remote party via a LAN.

---

### International standards

The PCS-1600/1600P Compact Conference Package complies with ITU-T Recommendations, for easy connection with remote parties overseas. (ITU-T Recommendations have been defined by WTSC (former CCITT).)

WTSC: World Telecommunications Standardization Committee

ITU: International Telecommunication Union

# Features

---

## Light weight and small size

The Compact Processor has come to miniaturized to 2.5 kg (5 lb 8 oz) of mass, and it has a small size (258 × 55 × 206 mm; 10 1/4 × 2 1/4 × 8 1/8 inches), you can easily install the Compact Processor on your TV monitor.

## Simple setup

The Compact Conference Package has the integral-type camera and microphone. You do not have to do a complicated connection; simply connect the TV monitor and the ISDN modular cable.

## Help menu and setup wizard

The Help menu appears on the monitor screen for guidance by pressing the HELP button. When you turn on the Compact Processor for the first time, the setup wizard appears on the monitor screen. Set up the system under its guidance.

## The Remote Commander can operate a Sony TV monitor

You can operate a Sony TV monitor with the Remote Commander supplied with the Compact Conference Package.

## Automatic tracking function

In addition to pan/tilt action, the automatic target tracking feature allows you to track a subject having the memorized color and brightness automatically.

## Echo canceler

A built-in echo canceler decreases sound echo from walls in the meeting room, allowing for clear sound reproduction.

## Equipped with the Memory Stick slot

Since the Compact Processor is equipped with the Memory Stick slot, you can use still images stored in the “Memory Stick”.

## Dual-monitor system

Two monitors can be used with the system, one is for moving picture and the other is for still image.

# System Configuration

The PCS-1600/1600P Compact Conference Package is a basic system that can be enhanced with variety of optional equipment.

## Basic System Equipment

The PCS-1600/1600P Compact Conference Package forms the basis of the PCS-1600 series system.

The PCS-1600/1600P Compact Conference Package consists of the following units:

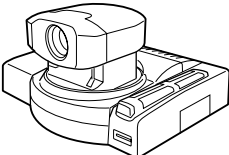
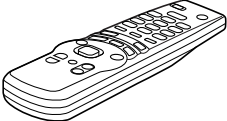
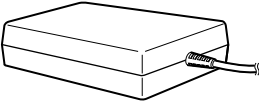
Unit	Description
PCS-P160/P160P Compact Processor PCS-C160/C160P Camera 	Contains the video codec, audio codec, echo canceler, network interfaces and system controller. This unit has an integral-type camera and microphone.
PCS-R160 Remote Commander 	Controls the Compact Processor. This can also be used to operate a Sony TV monitor.
PCS-AC15 AC adaptor 	Provides the power supply to the Compact Processor.

## Options

### TV monitor

A TV monitor is required for your meetings.

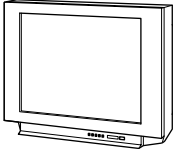
Unit	Description
TV monitor 	A TV is used as a meeting monitor and speaker. It displays the remote party, graphics, and menus. If you use a Sony TV, you can operate it with the Remote Commander supplied with the Compact Conference Package. Two monitors are required for a dual-monitor system.

### Other options

The following optional devices are also available to improve your meetings.

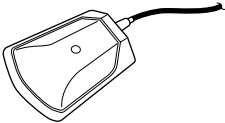
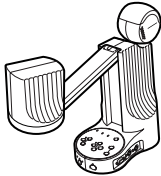
Unit	Description
PCS-A300 Microphone 	Allows you to accommodate extra two or three participants. You can connect two microphones. However, you cannot use both the built-in microphone and the external microphone at the same time.
PCS-DS150/DS150P Document Stand 	This document camera can transmit the video signal to the Compact Processor using infrared rays, without connecting a cable to the Compact Processor. You can easily transmit the RGB signal of a PC to the Compact Processor.

<b>Unit</b>	<b>Description</b>
PCS-I160 BRI Board	Provides two ISDN jacks. The connection with 6B channels is available.
PCS-I161 V.35 Board	Provides the V.35 connector. The connection via the V.35 interface is available.
PCS-K32 V.35 Conversion Connector Cable	Connects one end to the V.35 connector (on the PCS-I161 V.35 Board) and the other end to the terminal adaptor. (1 m, 3.3 ft)
PCS-K60 S-video cord	Connects one end to the S-video jack on the video equipment and the other end to the Compact Processor.
PCS-UC160 Upgrade Kit	Allows you to use this unit as the MCU (Multipoint Control Unit).
PCS-UC161 Upgrade Kit	Allows you to hold a meeting on the LAN that corresponds to H.323.

# Basic System Connection

Connect the TV monitor and the AC adaptor to the Compact Processor, and connect to the ISDN line with the supplied ISDN modular cable.

The following cables; the ISDN modular cable and the audio cord, each cable is equipped with the color label. When connecting these cables, match the label color with the color of the connector name printed on the rear panel.

## Notes

- Be sure to turn off all the equipment before making any connections.
- If your TV has the 21-pin connector, use the supplied 21-pin adaptor. (PCS-1600P only)

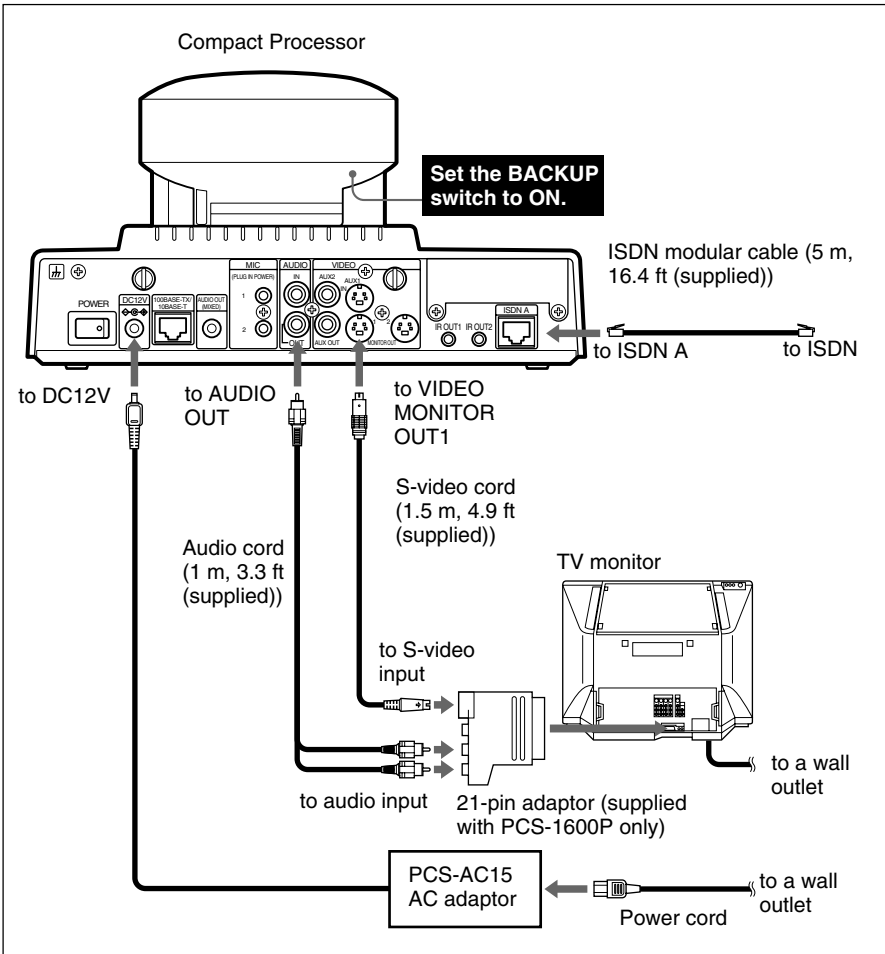

## Inserting Batteries into the Remote Commander

The supplied Remote Commander controls most of the functions. This section describes how to insert batteries into the Remote Commander.

- 1 Remove the battery compartment cover.

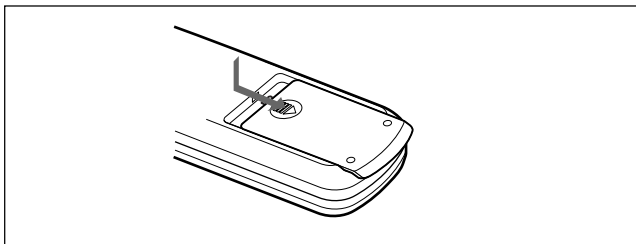

- 2 Insert two size AA (R6) batteries (supplied) with correct  $\oplus$  and  $\ominus$  polarity into the battery compartment.

When inserting the batteries, be sure to put the negative end at first.

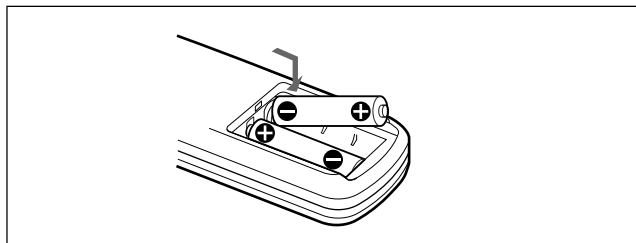

### Caution

Be sure to place the negative  $\ominus$  end of the battery at first. If you place the positive  $\oplus$  end at first, there is a possibility of damaging the insulated film covering the battery and creating a short circuit.

- 3 Replace the cover.

# Preparing the System

## Battery life

When the Remote Commander no longer functions properly, replace both the batteries.

## Notes on batteries

To avoid possible damage from battery leakage or corrosion, observe the following:

- Be sure to insert the batteries in the correct direction.
- Do not mix old and new batteries, or different types of batteries.
- Do not attempt to charge dry-cell batteries.
- If you do not intend to use the Remote Commander for a long time, remove the batteries.

If battery leakage occurs, clean the battery compartment and replace all the batteries.

## Preparing the TV Monitor

Insert the IR repeater below the remote sensor of the TV monitor. Once you set the IR repeater, you can turn on the Compact Processor and a Sony TV monitor together by pressing the I/⏻ button on the Remote Commander.

If the IR repeater does not function properly, set Monitor Mode in the General Setup menu to MODE2 (PCS-1600); to MODE4 (PCS-1600P).

*For details on the Monitor Mode setting, see “General Setup Menu” on page 109.*

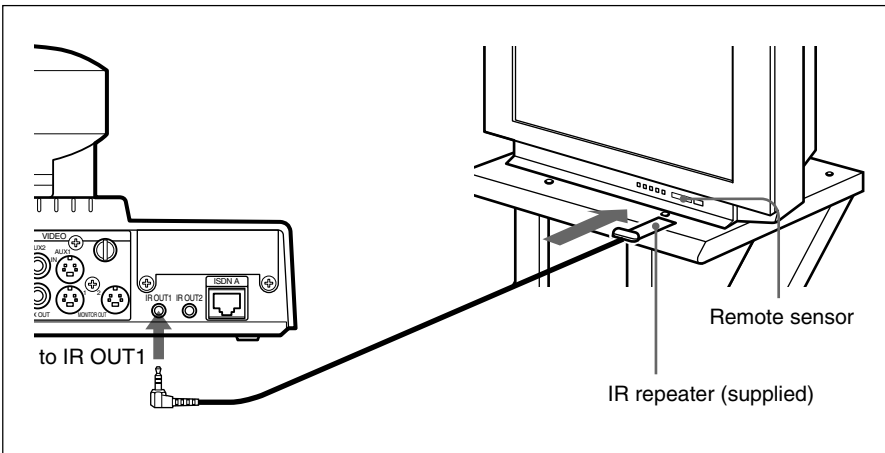

## When using a Sony TV monitor

The TV monitor can be operated from the Remote Commander.

*For details on operating the Remote Commander, see “To operate a Sony TV monitor” on page 154.*

## To adjust the TV monitor screen

Use the controls on the TV monitor to adjust the screen (picture, hue, contrast, brightness, and sharpness).

*For details on adjusting the screen, refer to the operating instructions supplied with the TV monitor.*

### Note

Do not activate the surround function of the TV monitor. This causes strange sounds since the echo canceler on the Compact Processor will not function properly.

## Setting the Initial Volume Level on the TV

When you adjust the volume, use the VOLUME/DOC-BRIGHT +/- buttons on the Remote Commander.

- 1 Set the volume level to the middle position by pressing the VOLUME/DOC-BRIGHT +/- buttons on the Remote Commander.



- 2 Adjust the volume with the TV monitor's control.

Set it to the proper level for listening to a remote party.

## Installing the Compact Processor

When you install the Compact Processor, use the supplied Velcro. This will prevent the Compact Processor from sliding off.

- 1** Stick one side of the supplied Velcro to the bottom of the Compact Processor.

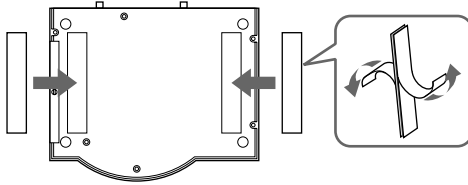

- 2** Stick the other side of the Velcro to the top of the TV monitor.
- 3** Attach the Compact Processor and the TV monitor by securing the Velcro.

# Turning the System On/Off

This section describes how to turn on and off the Compact Processor.

## Note

Set the CONF/DOC/TV selector on the Remote Commander to “CONF” when operating the Compact Processor.

## Turning On

The following describes how to turn on the Compact Processor.

- 1 Make sure the TV monitor is on standby.

*For details on how to set the TV monitor into a standby state, refer to the operating instructions supplied with the TV monitor.*

- 2 Turn on the power of any other equipment to be used during the meeting.
- 3 Set the POWER switch on the rear of the Compact Processor to on.

Soon, the Compact Processor and the TV monitor are turned on.

The POWER lamps (green) on the camera and the Compact Processor light up, and the self-diagnostic starts. The picture shot by the local camera appears on the monitor screen after the self-diagnostic is completed.

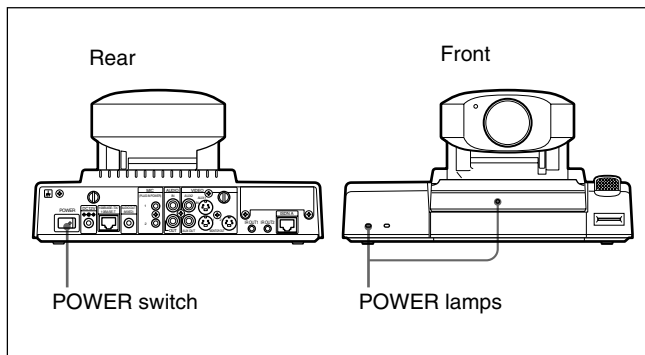

## Note

After the power is turned on, the camera performs training movements. Be careful not to catch your finger.

## Sleep function

The Compact Processor is turned into sleep mode to save power, if you do not operate the Compact Processor for about 1 to 99 minutes.

The POWER lamp on the main unit flashes while in sleep mode.

Once a call comes in, the sleep function is automatically released.

### To release the sleep function

Press any of the buttons on the Remote Commander.

### To set the time that the unit turns into sleep mode

Set the time by setting Sleep Time in the General Setup menu. If you do not want to use the sleep function, set Sleep Mode to Off.

*For details on the Sleep Time and Sleep Mode settings, see “General Setup Menu” on page 109.*

## Notes

- The POWER lamp on the camera does not flash even if the system is in sleep mode.
- A Sony TV monitor is turned into standby mode.

## When the Compact Processor is turned on for the first time

The setup wizard appears on the monitor screen after the self-diagnostic is completed.

Register your local system data following the wizard.

- 1 Select your language used for menu and message indications.  
**Language:** Selects a language from English, French, German, Japanese, Spanish, Italian, or Chinese.

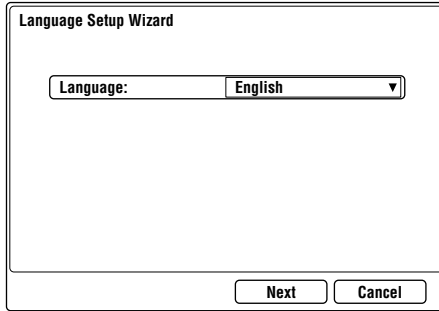

The image shows a dialog box titled "Language Setup Wizard". It contains a single dropdown menu labeled "Language:" with "English" selected. At the bottom of the dialog are two buttons: "Next" and "Cancel".

- 2 Select Next with the joystick on the Remote Commander, then press the joystick.

The next wizard appears on the monitor screen.

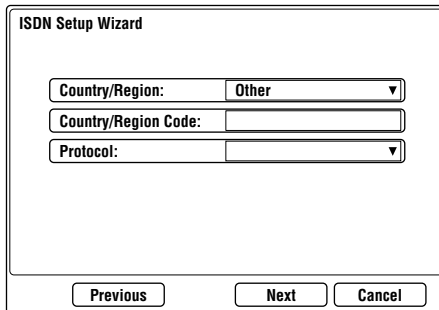

The image shows a dialog box titled "ISDN Setup Wizard". It contains three input fields: "Country/Region:" with a dropdown menu showing "Other", "Country/Region Code:" with a text box, and "Protocol:" with a dropdown menu. At the bottom of the dialog are three buttons: "Previous", "Next", and "Cancel".

- 3 Set up the following items.

**Country/Region:** Selects your country or region.

**Country/Region Code:** Enters your country code or region code in the box. (e.g., enter "1" for the USA.)

**Protocol:** Selects the network switch type. (This is only for the USA and Canada.)

(Continued)

- 4 Select Next with the joystick on the Remote Commander, then press the joystick.

The next wizard appears on the monitor screen.

The screenshot shows a rectangular window with a double border. At the top, there are two column headers: "Area Code" and "Local Number". Below "Area Code" are two input fields labeled "A1:" and "A2:". Below "Local Number" are two empty input fields. At the bottom left of the window is a button labeled "Auto SPID". At the bottom center of the window are three buttons: "Previous", "Next", and "Cancel".

- 5 Set up the following items.

**Area Code:** Enters your area code. Do not enter the first zero number of your area code. (e.g., enter only “408” for California.)

**Local Number:** Enters your telephone number and sub-address (if you set your sub-address). Enter the asterisk (\*) after the telephone number, then enter the sub-address. You cannot use the alphabet in a sub-address.

### When you select Auto SPID

You can automatically set up the Area Code, Local Number on this page, and SPID items on the next page.

#### Notes

- “Auto SPID” is only for the USA and Canada.
- If you have installed the optional PCS-I160 BRI Board, the boxes B1 to C2 are displayed. Register information in the boxes B1 to C2.

- 6** Select Next with the joystick on the Remote Commander, then press the joystick.

The next wizard appears on the monitor screen. (This is only for the USA and Canada.)

**SPID**

A1:

A2:

B1:

B2:

C1:

C2:

*For details on the SPID registration, see “SPID Registration for Customers in the USA” on page 92.*

- 7** Select Next with the joystick on the Remote Commander, then press the joystick.

The next wizard appears on the monitor screen.

**LAN Setup Wizard**

DHCP Mode:  ▼

Host Name:

IP Address:  .  .  .

Network Mask:  .  .  .

Gateway Address:  .  .  .

DNS Address:  .  .  .

*(Continued)*

## 8 Set up the following items.

**DHCP Mode:** Sets up the DHCP (Dynamic Host Configuration Protocol).

**Auto:** Automatically gets your IP address, network mask, gateway address, and DNS address.

**Off:** Sets DHCP to OFF. When set to OFF, enter your IP address, network mask, gateway address, and DNS address.

**Host Name:** Enter your host name.

**IP Address:** Enter your IP address.

**Network Mask:** Enter your network mask.

**Gateway Address:** Enter your default gateway address.

**DNS Address:** Enter your DNS (Domain Name System) server address.

### Tip

When DHCP Mode is set to Auto, you can verify the acquired IP address in the Machine Information menu (page 116).

## 9 Select Next with the joystick on the Remote Commander, then press the joystick.

The message for verification appears.

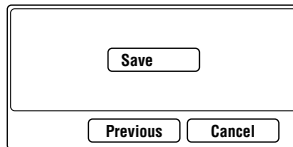

## 10 Select Save with the joystick on the Remote Commander, then press the joystick.

The setting is saved.

### To cancel the setup

Select Cancel with the joystick on the Remote Commander, then press the joystick.

### To go back to the previous wizard

Select Previous with the joystick on the Remote Commander, then press the joystick.

## Setting the System (Compact Conference Package) to be on Standby

When the system is on standby, you can turn the system on with the I/⏻ button on the Remote Commander.

- 1 Press the I/⏻ button on the Remote Commander.

The indication “Power off?” appears on the monitor screen.

- 2 Select OK with the joystick on the Remote Commander, then press the joystick, or press the I/⏻ button on the Remote Commander.

Both the Compact Processor and the TV monitor are turned into standby.  
The STANDBY lamp (orange) lights up.

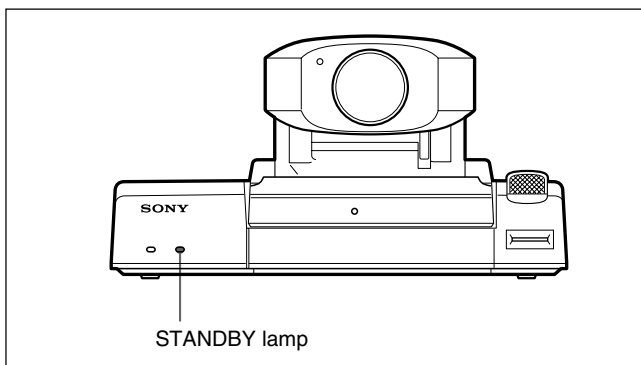

### To cancel turning into standby

Select Cancel using the joystick on the Remote Commander in step 2, then press the joystick.

#### Note

Do not turn off the POWER switch on the rear panel while the menu is displayed on the monitor screen.

# Turning the System On/Off

## On the Help Menu

Press the HELP button on the Remote Commander, either a Help bubble on the current operation or the Help screen appears.

## On the Version And Option Indications

You can check the Compact Processor version and the option installed into the unit, with the Machine Information menu.

*For details on the Machine Information menu, see “Machine Information Menu” on page 116.*

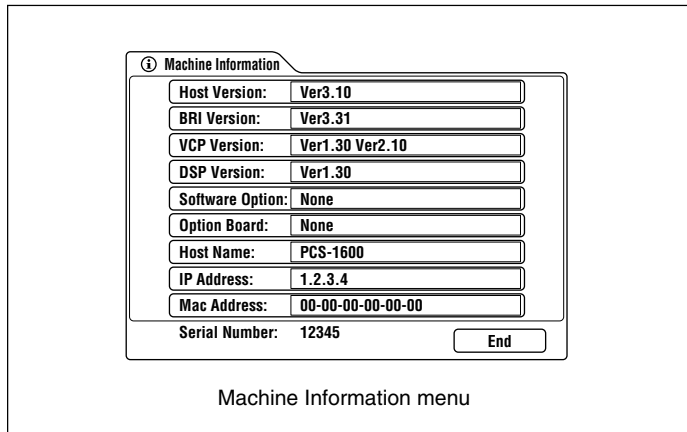

## Turning Off

The following describes how to turn off the Compact Processor.

- 1** Set the POWER switch on the rear of the Compact Processor to off.
- 2** Turn off the power of any other equipment which was used during the meeting.

### Notes

- If you are not going to use the system for an extended period, set the POWER switch to off.
- You cannot receive any calls from remote parties if the POWER switch is set to off.

# How to Operate the Menu

The different menu is opened whether the system is in communication or not.

## Switching the Menu Not in Communication

The following launcher menu is always displayed when the system is not in communication. Select the desired menu with the joystick on the Remote Commander, then press the joystick. The desired menu will be opened.

### Launcher menu

The following explains how to use the Launcher menu.

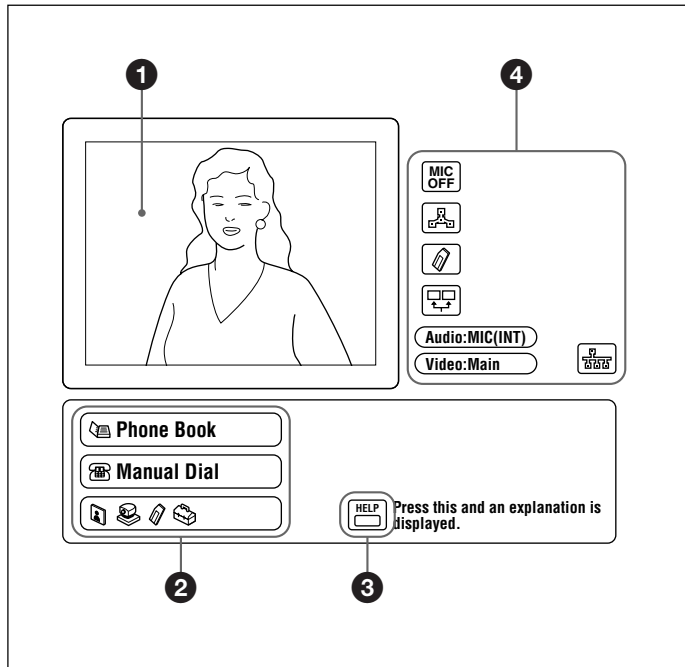

### 1 The screen

The image captured by the local camera is displayed here. When you select the screen using the joystick on the Remote Commander (the screen border turns yellow), and press it down, you can then adjust the camera angle up, down, left or right, with the joystick. In addition, if you press the T-button on the Remote Commander ZOOM/TV-CH button, the picture is enlarged; if you press the W-button, it is reduced in size. Once you have the picture you want, pressing the joystick on the Remote Commander ends the camera angle adjustment mode. For more details on camera angle adjustment, see page 57.

### 2 Phone Book/Manual Dial/

You can toggle through the menus using the joystick. For an explanation of each menu, see pages 33 through 34.

### 3 HELP

When you press the HELP button on the Remote Commander, an explanation is provided for each menu. When you press the HELP button again, the explanation disappears.

### 4 Icons

The following provides an explanation for each icon.

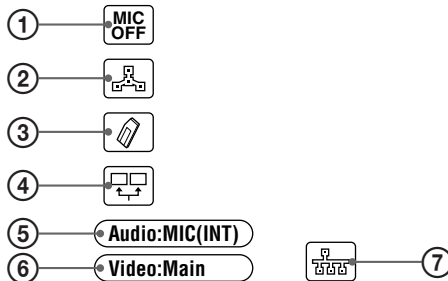

(Continued)

- ① **Mic mute function:** When this icon is displayed, the sound from the local position will not be sent to remote parties. For more details, see page 54.
- ② **Multipoint mode:** This icon is displayed when the Multipoint mode is set to ON. For more details, see page 107. (To use Multipoint mode, a PCS-UC160 Upgrade Kit (not supplied) is required.)
- ③ **“Memory Stick”:** This icon is displayed when there is a “Memory Stick” inserted in the “Memory Stick” slot.
- ④ **Dual monitor:** This icon is displayed when the Dual monitor item of the General settings is set to ON. For more details, see page 109.
- ⑤ **Audio input:** This icon is displayed to show the audio input. To enable switching of the input, set the Audio Switching item in the Audio settings. For more details, see page 64.
- ⑥ **Video input:** This icon is displayed when video input is sent to a monitor. To switch the input, press the INPUT SELECT button on the Remote Commander, then select input with the joystick. For more details, see page 64.
- ⑦ **LAN status:** This item is displayed in blue when the LAN is available, and in red when it is not.

## Phone Book menu

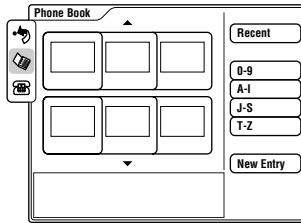

This is used to hold a meeting with a registered party or to register or modify a party. (Pressing the PHONE BOOK button on the Remote Commander accesses the Phone Book menu directly.)

*For details on the Phone Book menu, see pages 47, 48, 81 to 88.*

## Manual Dial menu

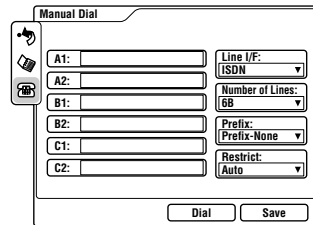

This is used to hold a meeting with an unregistered party.

*For details on the Manual Dial menu, see pages 42 to 46.*

## Still Image menu

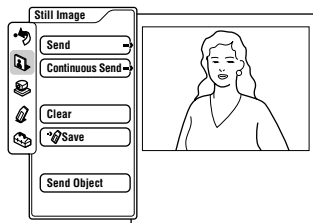

This is used to control a still image. (Pressing the STILL IMAGE button on the Remote Commander accesses the Still Image menu directly.)

*For details on the Still Image menu, see pages 69 to 72.*

## Camera Angle menu

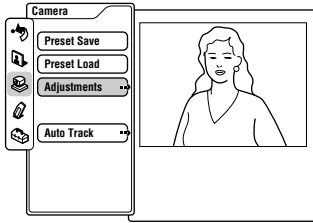

This is used to control the angle and zoom of the camera. (Pressing the CAMERA button on the Remote Commander accesses the Camera Angle menu directly.)

*For details on the Camera Angle menu, see pages 56 to 63.*

## Memory Stick menu

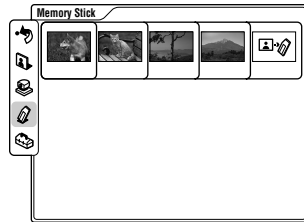

This is used to use a "Memory Stick." You can access this menu only when the "Memory Stick" is inserted.

*For details on the Memory Stick menu, see pages 66 to 69.*

## Setup menu

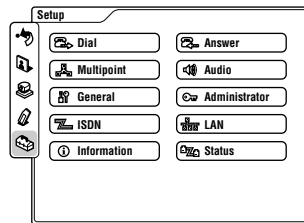

This is used to register or modify the setup of the system.

*For details on the Setup menu, see pages 89 to 116.*

## Switching the Menu in Communication

Press the STILL IMAGE button on the Remote Commander in communication, the Still Image menu is opened. Select the desired menu with the joystick on the Remote Commander, then press the joystick. The desired menu will be opened.

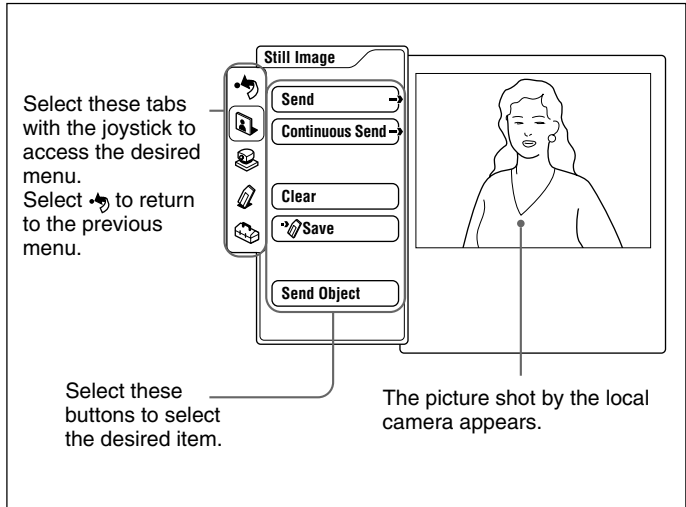

## Still Image menu

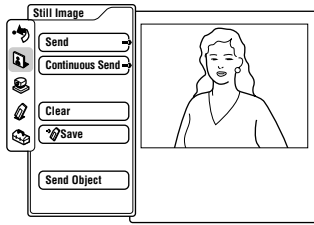

This is used to control a still image. (Pressing the STILL IMAGE button on the Remote Commander accesses the Still Image menu directly.)

*For details on the Still Image menu, see pages 70 to 72.*

## Camera menu

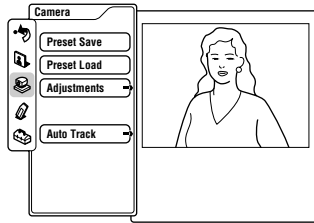

This is used to control the camera. (Pressing the CAMERA button on the Remote Commander accesses the Camera menu directly.)

*For details on the Camera menu, see pages 56 to 63.*

## Phone Book menu

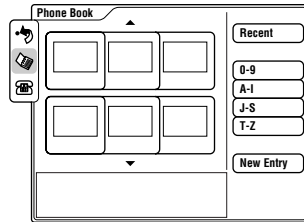

This is used to hold a meeting with a registered party or to register or modify a party. (Press the PHONE BOOK button on the Remote Commander.)

*For details on the Phone Book menu, see pages 47, 48, 81 to 88.*

### Memory Stick menu

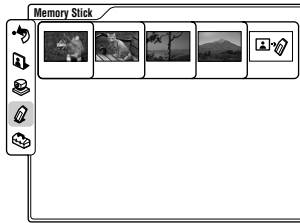

This is used to use a “Memory Stick.” You can access this menu only when the “Memory Stick” is inserted.

*For details on the Memory Stick menu, see pages 66 to 69.*

### Setup menu

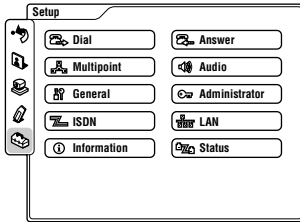

This is used to register or modify the setup of the system.

*For details on the Setup menu, see pages 89 to 116.*

## Operating the Menu

This describes the basic menu operation, taking the Dial Setup menu as an example.

- 1 Open the Dial Setup menu from the Setup menu (page 34).

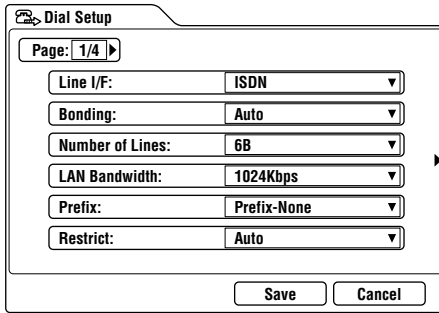

- 2 Select the desired item with the joystick on the Remote Commander, then press the joystick.

The settings of the selected item is pulled down.

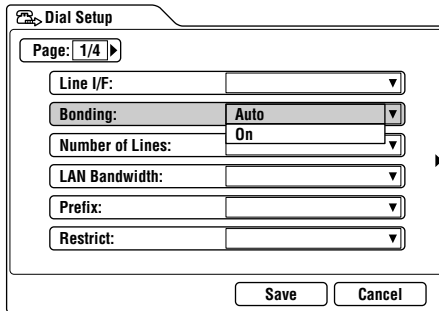

- 3 Select the desired setting with the joystick on the Remote Commander moved up or down, then press the joystick.
- 4 Select Save with the Remote Commander, then press the joystick.

The modification is complete.

### To page up or down the menu

Move the joystick on the Remote Commander to the right or left.

### To return to the previous level hierarchy of the menu

Press the RETURN button on the Remote Commander.

## Turning Off the Indicators displayed on the screen

Press the DISPLAY button on the Remote Commander to turn off the indicators displayed on the screen. To turn on the indicators, press it again.

### Note

You cannot turn off all of the indicators, depending on the indicator.

## Entering Characters

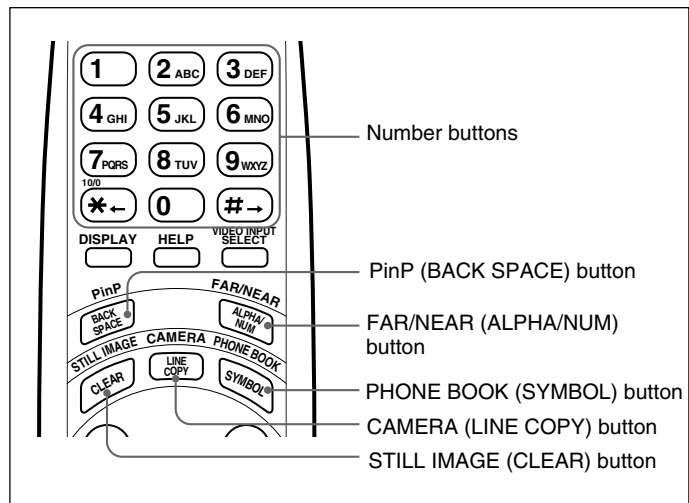

### To switch the input mode

Press the FAR/NEAR (ALPHA/NUM) button on the Remote Commander repeatedly to switch the input mode.

*(Continued)*

## **To enter characters**

Press the number buttons on the Remote Commander to enter the desired character. Each time you press the button, the character is input from among the alphabets on each button, or the numbers on each.

To enter special characters (symbols), press the PHONE BOOK (SYMBOL) button repeatedly to select a desired character.

## **To copy the number**

Press the CAMERA (LINE COPY) button on the Remote Commander. The number in the box above is copied to the next box.

## **To delete a character**

Press the PinP (BACK SPACE) button on the Remote Commander. The last entered character is deleted.

## **To delete all characters in a box**

Move the cursor to the box where you want to delete the entry, then press the STILL IMAGE (CLEAR) button on the Remote Commander.

# ***Basic Operation During a Meeting***

## **Calling a Remote Party**

You can start a meeting with a remote party by dialing. Once you have made a connection with the remote party, you can begin talking just like normal phone call.

The following describes how to call a remote party.

You have to register your local system data and set up the Compact Processor before starting a meeting.

*For details on registration and setup, see Chapter 4 “Registration and Setup.”*

### **Notes**

- Meetings using the V.35 interface are available when the optional PCS-I161 V.35 board has been installed.
- Meetings on a LAN are available when the system has been upgraded with the optional PCS-UC161 Upgrade Kit.

# Calling a Remote Party

## Calling an Unregistered Remote Party

The following launcher menu is always displayed on the monitor screen not in communication.

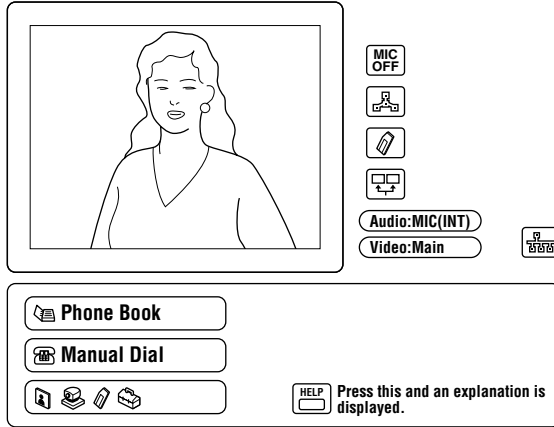

- 1 Select Manual Dial with the joystick on the Remote Commander, then press the joystick, or press the CONNECT/DISCONNECT (📞/📞) button or one of the number buttons on the Remote Commander.

The Manual Dial menu appears on the monitor screen.

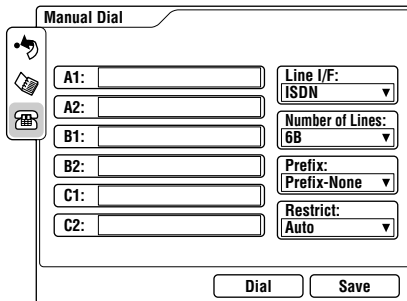

### Note

The B1 to C2 boxes are only displayed when you have installed the optional PCS-I160 BRI Board.

## 2 When connecting via the ISDN lines

Enter the telephone number of the remote party to have a meeting with in the A1 and A2 boxes.

- To copy a telephone number, press the CAMERA (LINE COPY) button. The number entered are copied to the next box.
- To delete the last number, press the PinP (BACK SPACE) button on the Remote Commander. The last number is deleted.

### Note

Do not enter your prefix number in these boxes. The prefix number will be set in step 4.

### When connecting on a LAN

When “LAN” has been selected as the line interface in step 3, enter the IP address (or its host name and domain name when using the DNS server) of the remote party to have a meeting with in the IP Address box. You can enter “.” (period) used for separation by moving the joystick to the right.

Move the joystick up or down to select the box, then enter the telephone number or IP address with the number buttons on the Remote Commander.

- To delete a telephone number or IP address, press the STILL IMAGE (CLEAR) button on the Remote Commander. The number or IP address entered is deleted.

## 3 Set up the line interface.

Select Line I/F with the joystick on the Remote Commander, then press the joystick. Select the desired setting with the joystick moving up or down, then press the joystick.

**ISDN:** Connects to a video conferencing system via a normal ISDN line, or via a dedicated line (with a 64 Kbps or 128 Kbps interface).

**ISDN (Telephone):** Connects to a phone to have a voice meeting via the normal ISDN line.

*(Continued)*

**V.35:** Connects to a TV conferencing system via the V.35 interface. (Option)

**LAN:** Connects to a TV conferencing system using a LAN. (Option)

### To set the number of lines to be connected for an ISDN call

When a call is made using ISDN lines, choose the number of lines to be used when the call is set up.

Select Number of Lines: with the joystick on the Remote Commander, then press the joystick down.

Set the number of lines by moving the joystick up or down.

**1B:** Connects via 1B channel.

**2B:** Connects via 2B channels.

**3B:** Connects via 3B channels.

**4B:** Connects via 4B channels.

**5B:** Connects via 5B channels.

**6B:** Connects via 6B channels.

### To select the LAN bandwidth to be used

When you are using a LAN, you can select the bandwidth to be used from among the settings below.

64 Kbps, 128 Kbps, 384 Kbps, 512 Kbps, 768 Kbps, 1024 Kbps, Other

When you choose “Other,” you must enter the value yourself.

Bandwidths from 1 to 1024 Kbps can be entered.

## 4 Select the prefix setting.

Select Prefix with the joystick on the Remote Commander, then press the joystick. Select the desired setting with the joystick moving up or down, then press the joystick.

**None:** Does not use the prefix number.

**Prefix-A:** Uses the setting A set in the Dial Setup menu.

**Prefix-B:** Uses the setting B set in the Dial Setup menu.

**Prefix-C:** Uses the setting C set in the Dial Setup menu.

*For details on the setting up the prefix number, see “Dial Setup Menu” on page 100.*

## 5 Select the ISDN transfer rate.

Select Restrict with the joystick on the Remote Commander, then press the joystick. Select the desired setting with the joystick moving up or down, then press the joystick.

**Auto:** Connects to a remote party with a normal ISDN line.

**56K:** Connects to a region or country with a 56 Kbps ISDN transfer rate.

### Note

When using the Compact Processor as the Multipoint, or holding a meeting on a LAN, the Restrict item cannot be set.

## 6 Select Dial with the joystick on the Remote Commander, then press the joystick, or press the CONNECT/DISCONNECT (📞/📞) button on the Remote Commander.

The system dials the number that is input in step 2, and the indication “Dialing (The line interface is indicated.)” appears on the monitor screen.

When the connection is completed, the indication “MEETING STARTS!” appears on the monitor screen.

### To cancel dialing before the connection is completed

Select Cancel with the joystick on the Remote Commander, then press the joystick, or press the CONNECT/DISCONNECT (📞/📞) button on the Remote Commander.

## Calling a Remote Party

---

### To save the number you entered in the Dialing list (in the Phone Book)

Select Save with the joystick on the Remote Commander, then press the joystick down.

The number you entered is saved in the list, and the List Edit menu is displayed.

---

### To set up other items than the items above

When More Options Enable is set to On in the Dial Setup menu, the More Options button is displayed at the lower part of the menu. Select More Options with the joystick on the Remote Commander, then press the joystick. The Dial Setup menu appears and you can set up the other items.

---

### Last-number redial function

When you access the Manual Dial menu again after you have used the Manual Dial menu once, the last number dialed is entered into the boxes.

#### **Notes**

This function does not work in the following situations:

- Once you turned off the power or turned the Compact Processor to standby/sleep.
- You have not dialed though you entered a number.
- You displayed the Manual Dial menu by pressing one of the number buttons on the Remote Commander.

## Calling a Registered Remote Party

### To call from the Phone Book

- 1** Press the PHONE BOOK button on the Remote Commander.

The Phone Book menu appears on the monitor screen.

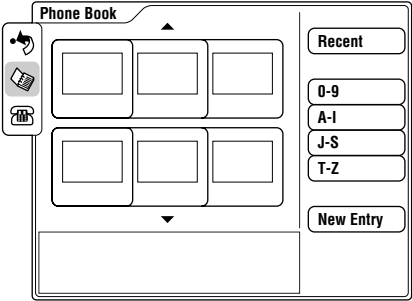

- 2** Select the remote party with the joystick on the Remote Commander, then press the joystick.

The sub-menu is opened on the monitor screen.

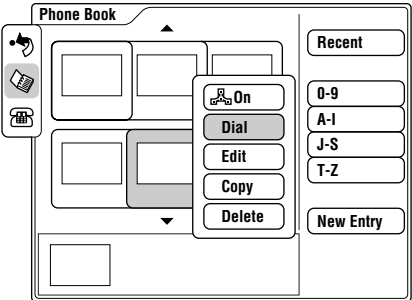

You can sort the list on the Phone Book menu.

*For details, see “To sort the list on the Phone Book menu” on page 48.*

*(Continued)*

# Calling a Remote Party

- 3 Select Dial with the joystick on the Remote Commander, then press the joystick, or press the CONNECT/DISCONNECT (📞/📞) button on the Remote Commander.

The system dials the selected remote party in step 2, and the indication “Dialing (The line interface is indicated.)” appears on the monitor screen.

When the connection is completed, the indication “MEETING STARTS!” appears on the monitor screen.

### To cancel dialing before the call is connected

Select Cancel with the joystick on the Remote Commander, then press the joystick, or press the CONNECT/DISCONNECT (📞/📞) button on the Remote Commander.

---

## To sort the list on the Phone Book menu

You can sort the list on the Phone Book menu.

The list on the Phone Book menu will be sorted by selecting the buttons at the right on the menu.

When you select Recent, most recently dialed six indexes are displayed.

When you select 0–9, A–I, J–S, or T–Z, and select the desired letter, six indexes which start from the specified letter are displayed.

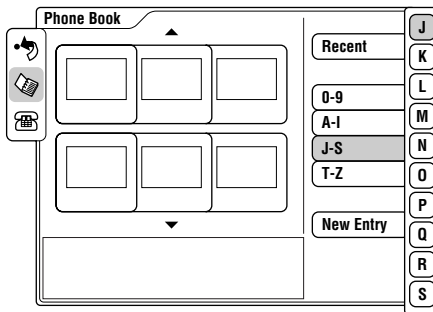

### Tip

You can use the number buttons (0–9) on the Remote Commander instead.

# Receiving a Call

When a call comes in, the connection process differs depending on the setting of the answer mode.

## Auto answer mode

The system automatically receives the call and starts the meeting. However, even if you are not ready to start the meeting, the local picture will be displayed on the remote party's monitor screen.

## Manual answer mode

Incoming calls are not automatically connected. You must manually connect the call.

You can start the meeting whenever you are ready.

### Notes

- The POWER switch of the Compact Processor must be set to on to receive a call.
- Make sure that the TV monitor is on standby.

## Setting the Answer Mode

When you select the auto answer mode, set Auto Answer to On in the Answer Setup menu. When you select the manual answer mode, set it to Off.

*For details on the Auto Answer item, see "Answer Setup Menu" on page 105.*

## Answering Calls in Auto Answer Mode

The system automatically receives a call when it is on standby or in sleep mode.

When a call comes in, the Compact Processor starts ringing, and the indication "Incoming Call" appears on the monitor screen.

Once the connection has been made, the remote party appears on the local monitor screen, and the local party appears on the remote screen. You are now ready to hold your meeting. The indication "MEETING STARTS!" appears on the monitor screen.

## Answering Calls in Manual Answer Mode

When your system is in manual answer mode, you need to connect incoming calls manually.

When a call comes in, the Compact Processor starts ringing, and the indication “Incoming Call. Respond?” appears on the monitor screen.

Select OK with the joystick on the Remote Commander, then press the joystick.

Once the connection has been made, the remote party appears on the local monitor screen, and local party appears on the remote screen. You are now ready to hold your meeting. The indication “MEETING STARTS!” appears on the monitor screen.

### **If you do not want to receive a call**

Select Cancel with the joystick, then press the joystick. The Compact Processor stops ringing.

---

## **If you are operating the system when a call comes in**

The indication “Incoming Call. Respond?” appears on the monitor screen. If you receive the call, Select OK with the joystick on the Remote Commander, then press the joystick. If you cannot receive the call according to your current operations, Select Cancel with the joystick on the Remote Commander, then press the joystick.

---

## **When the system fails to make a connection**

The indication “CANNOT COMPLETE CONNECTION” appears along with an ISDN cause code and a message on the monitor screen.

*For details on ISDN cause codes and messages, see “On Screen Messages” on page 155.*

---

## **When the optional PCS-UC161 Upgrade Kit has been installed**

If a call comes in via the ISDN line during the meeting on a LAN, the Compact Processor is busy.

# Checking the Connection Status

During a meeting, you can check the status of the communication. Elapsed time also appears on the monitor screen during a meeting.

- 1 Open the Setup menu.
- 2 Select Communication Status with the joystick on the Remote Commander, then press the joystick.

The Communication Status menu appears.

The screenshot shows the 'Communication Status' menu with a 'Page: 1/3' indicator. The menu is organized into several sections:

Line I/F	BRI	Camera Control	ON
Rate	2 x 64K	Data Control	OFF

	(Encode)	(Decode)		(Encode)	(Decode)
Audio Mode	G.728	G.728	LSD Rate	6400	6400
Video Mode	H.261 CIF	H.261 CIF	MLP Rate	OFF	OFF
Frame Rate	15fps	15fps	HMLP Rate	OFF	OFF

An 'End' button is located at the bottom right of the menu.

## Tip

You can also display the Communication Status menu by continuously pressing the 0 button on the Remote Commander twice.

- 3 Check the status:

**Line I/F:** Displays the line interface being used.

**Rate:** Displays the number of lines and the transfer rate being used.

**Camera Control:** Displays the far end camera control protocol.

**Data Control:** Displays the data transmission protocol.

The items below are separately displayed in the columns Encode and Decode.

The columns Encode indicate the status being sent, the columns Decode indicate the status being received.

**Audio Mode:** Displays the audio encoding system.

**Video Mode:** Displays the video encoding system.

- Frame Rate:** Displays the maximum frame rate of the motion picture.
- LSD Rate:** Displays the LSD (Low Speed Data) rate.
- MLP Rate:** Displays the MLP (Multi Layer Protocol) rate.
- HMLP Rate:** Displays the HMLP (High speed Multi Layer Protocol) rate.

**To close the Communication Status menu**

Select End with the joystick on the Remote Commander, then press the joystick. The menu returns to the Setup menu.

---

**On elapsed time**

When you set Time Display to On in the General Setup menu, the elapsed time appears on the monitor screen during a meeting. You can use it as a guide, and it is convenient for checking communication costs. If you do not need to display the elapsed time, set Time Display to Off.

*For details on the Time Display setting, see “General Setup Menu” on page 109.*

# Adjusting the Sound

## Adjusting the Volume

You can adjust the volume sent from remote parties. Press the VOLUME/DOC-BRIGHT + button to increase the volume; the VOLUME/DOC-BRIGHT – button to decrease it. The volume bar appears on the monitor screen. After a while, the bar automatically disappears if you do not operate.

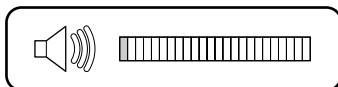

### Notes

- You have to set the volume of the TV monitor at first.
- If feedback occurs, decrease the volume.

## Muting Local Conversations – Mute Function

You can mute local conversations. If you press the MIC/DOC-DARK button, local conversations will not be sent to the remote party. When local conversations are muted, the mute indication  is displayed on the monitor screen.

### To cancel muting

Press the MIC/DOC-DARK button on the Remote Commander again.

The mute indication  disappears from the monitor screen.

## Synchronizing Voice and Motion – Lip Synchronization

During the meeting, voice and motion may lose synchronization.

The automatic lip synchronization function built into the system solves this problem by closely synchronizing audio and video before they are transmitted to the remote party.

---

When you use the lip synchronization, set Lip Sync to On in the Audio Setup menu. When you do not use the lip synchronization, set it to Off.

*For details on the Lip Sync setting, see “Audio Setup Menu” on page 108.*

**Note**

The lip synchronization function only works for your own party. To activate the lip synchronization function at the remote party, you must ask them to do so.

## On the Echo canceler

The Compact Processor is equipped with the echo canceler. When you use the built-in echo canceler, set Echo Canceler to Internal in the Audio Setup menu; when not in use, set to Off. If you use an echo canceler of external audio equipment connected to the system, set Echo Canceler to External. It should normally be set to Internal.

*For details on the Echo Canceler setting, see “Audio Setup Menu” on page 108.*

# Adjusting the Camera

You can adjust the local camera to obtain the best viewing results.

During communication, you can also adjust the remote camera, and adjust images being sent from the remote camera.

## Notes

- A malfunction may occur if the local and remote parties try to adjust the same camera at the same time.
- You cannot control the remote camera during a meeting if H.281 is not selected as the far end camera control protocol.
- You cannot control the remote camera during a meeting if the Compact Processor is used as the MCU.
- If you adjust the camera angle during a meeting, a motor noise may be picked up by the microphone, and it may be heard through a speaker. This is not a malfunction.

If you frequently adjust the camera, we recommend you to use the optional PCS-A300 Microphone. If you use a PCS-A300 microphone, and make the necessary settings changes, the internal microphone will cease functioning.

*For details on the setting when using the PCS-A300 Microphone, see “Audio Setup Menu” on page 108.*

## To display the picture on the whole screen

While the Camera menu is displayed, to display a full-screen image, press the PinP button on the Remote Commander to select the appropriate item on the Camera menu. The picture will be displayed on the whole screen. To return to the previous screen, press the joystick, the RETURN button, or the PinP button on the Remote Commander.

---

## To select the camera to be adjusted

Before adjusting the camera, you must select the local or remote camera to be controlled.

Press the FAR/NEAR button on the Remote Commander, then select the far site or near site camera.

When the remote camera is selected, the indication **[FAR]** appears on the monitor screen.

When the local camera is selected, the indication **[FAR]** does not appear on the monitor screen.

**Note**

You cannot control the remote camera if you do not set Far End Camera Control to On in the Dial Setup menu at the local, and set Far End Camera Control to ON in the Answer Setup menu at the remote.

**Adjusting the Camera Angle and Zoom**

You can adjust the camera angle and zoom.

**To adjust the camera angle**

Move the joystick on the Remote Commander up, down, to the left, or to the right to view any areas not currently covered by the camera. (Select Camera Angle after selecting the image portion and pressing joystick down, when the system is not in communication.)

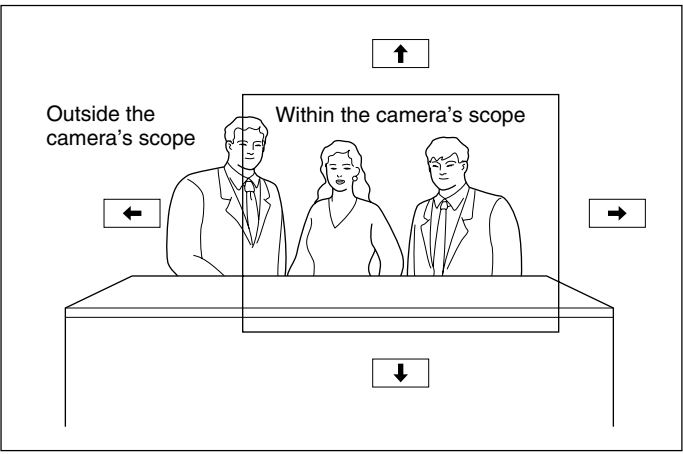

**To adjust zoom**

Press the ZOOM/TV-CH T button on the Remote Commander to zoom in or the ZOOM/TV-CH W button to zoom out. Adjust zoom to display the desired picture.

## Adjusting Focus and Brightness

Focus and brightness are automatically adjusted. We recommend that you do not use the manual adjustments since the camera automatically adjust itself for the best focus and brightness.

Press the CAMERA button on the Remote Commander to access the CAMERA menu. Select Adjustments with the joystick on the Remote Commander in the Camera menu, then press the joystick. The guidance will appear and you can adjust the focus and brightness.

---

### To adjust focus manually

Press the number button 0 on the Remote Commander, the focus adjustment setting changes to the automatic adjustment.

Press the **#→** button on the Remote Commander repeatedly to move the focus point further away to the camera. Press the **\*←** button on the Remote Commander repeatedly to move the focus point closer to the camera.

---

### To adjust brightness

Press the number button 9 on the Remote Commander repeatedly to make the picture brighter. Press the number button 7 on the Remote Commander repeatedly to make the picture darker.

---

### To shoot with the backlight function

When you shoot a subject with the light source behind the subject, use the backlight function.

Each time you press the number button 8 or MIC/DOC-DARK button, the backlight function is switched between on and off.

## Presetting Angle and Zoom Settings

You can store the camera settings in memory up to six presets, and each preset has the angle and zoom settings. Once a setting has been stored, you can easily recall a setting from the six presets.

### To store a setting

- 1 Press the CAMERA button on the Remote Commander.

The Camera menu appears.

- 2 Select Preset Save with the joystick on the Remote Commander, then press the joystick.
- 3 Select the preset number which you want to store the setting with the joystick on the Remote Commander, then press the joystick.

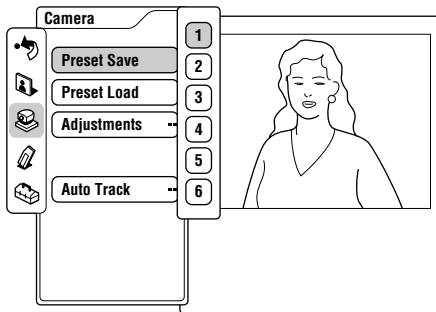

- 4 Set up the angle and zoom.

*For details on the angle and zoom settings, see “Adjusting the Camera Angle and Zoom” on page 57.*

- 5 Select Preset Save with the joystick on the Remote Commander, then press the joystick.

The setting will be stored under the selected number.

## Tip

You can directly store the setting to the desired preset number by pressing and holding one of the number buttons (1 to 6) on the Remote Commander or by continuously pressing the # button and one of the number buttons (1 to 6).

## To recall a preset

- 1 Select Preset Load with the joystick on the Remote Commander, then press the joystick.
- 2 Select the number button (1 to 6) with the joystick on the Remote Commander, then press the joystick.

The camera is automatically adjusted by the preset under the selected number.

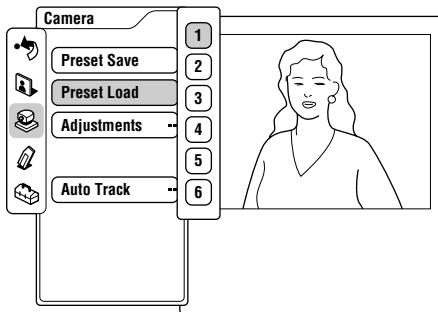

## Tip

You can directly recall a preset by pressing one of the number buttons (1 to 6) on the Remote Commander during communication.

## On backup

The memories of the preset are erased when the POWER switch on the Compact Processor is set to off. To retain those memories, set the BACKUP switch at the rear of the camera to ON.

**Notes**

- In the camera, the built-in lithium battery acts as the power source for retaining the memories and is kept charged as long as the system is used. However, if the system is used for shorter period of time with the BACKUP switch set to ON, the battery is gradually discharged. If you do not use the system at all for almost 12 weeks, the battery is completely discharged. To retain the memories of the settings, you should recharge the battery.
- To recharge the battery, connect the camera to the Compact Processor and leave it for approximate 48 hours with the POWER switch set to on.

## Tracking a Subject Automatically — Automatic Target Tracking Function

You can have the camera memorize a particular color or brightness so that it automatically tracks a subject having the memorized color or brightness.

If a subject almost goes off the screen, the camera performs the pan/tilt action so that the subject is placed back in the middle of the screen.

**Note**

The automatic target tracking function is only available for the local camera.

- 1** Press the CAMERA button on the Remote Commander.

The Camera menu appears.



- 2 Select Auto Track with the joystick on the Remote Commander, then press the joystick.

The frame appear on the monitor screen.

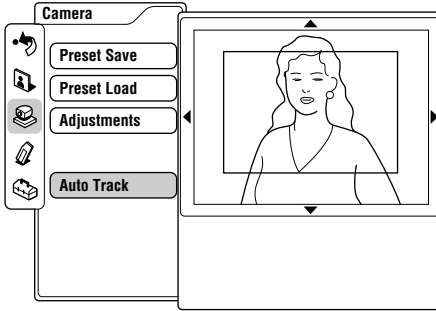

- 3 Use the joystick and the ZOOM/TV-CH buttons on the Remote Commander to place a subject into the frame.

**Notes**

- Be sure to place the subject so that the portion uniform in brightness and color is in the frame.
- The camera might not recognize a subject if the portion different from the subject in brightness and color, such as the backdrop, is placed together in the frame.

- 4 Press the joystick on the Remote Commander.

The indication  appears on the monitor screen. The automatic target tracking function starts and the frame disappears from the monitor screen.

**To cancel the automatic target tracking function**

Select Auto Track Stop with the joystick on the Remote Commander, then press the joystick.

The indication  disappears from the monitor screen.

---

## If the frame is repeatedly extended to the full screen

The camera does not recognize the subject. Repeat steps **2** to **4** again.

---

## If the lamp at the side of the lens lights up

The camera is not capturing the memorized subject correctly. In this case, perform the pan/tilt operation so that the subject comes into the screen, or have the subject memorized onto the camera again.

### **Note**

When the frame does not track the subject, repeat steps **2** and **4** until the frame starts tracking the subject while adjusting the lighting and the portion of the subject so that the color and brightness of the subject is optimized.

# Selecting the Picture and Sound

You can select the picture and sound from both the local and remote sites equipment.

---

## To switch the picture

### To switch the picture displayed on the monitor from the local or remote picture

Press the FAR/NEAR button on the Remote Commander, then switch the picture by selecting the icons on the monitor screen with the joystick on the Remote Commander.

Each time you press the button, the picture on the monitor screen switches between the local and the remote.

### To switch the video that will be sent to the remote sites

Press the VIDEO INPUT SELECT buttons on the Remote Commander to switch the picture on the screen.

**Main:** The main camera is selected.

**Object:** The optional PCS-DS150/DS150P Document Stand is selected.

**AUX1:** The equipment connected to the VIDEO IN AUX 1 jack is selected.

**AUX2:** The equipment connected to the VIDEO IN AUX 2 jack is selected.

---

## To switch the sound

Set Input Select in the Audio Setup menu as follows:

**MIC:** The microphone is selected.

**AUX:** The external equipment is selected.

**MIC + AUX:** Both the microphone and the external equipment are selected.

*For details on the Input Select item, see “Audio Setup Menu” on page 108.*

### Note

The audio input of the remote cannot be switched from the local system.

# Monitoring Yourself in the Inset Window

The inset window allows you to monitor your own party while viewing the remote party. **(Picture-in-picture function)**

Press the PinP button on the Remote Commander in communication.

If an inset window is not displayed, the inset window appears on the monitor screen.

When it is already displayed, each time you press the PinP button, the inset window moves as follows:

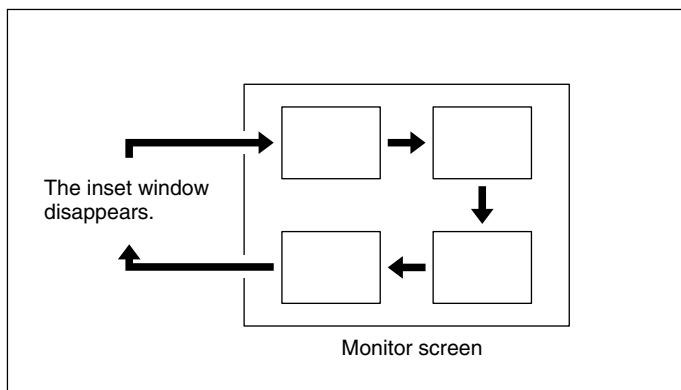

## Notes

- The inset window is displayed at the same position as it was displayed last. If the inset window is not displayed last, it is not displayed.
- The inset window does not appear when your system is not connected to a remote party.

# Displaying a Still Picture

You can use still pictures stored in a “Memory Stick.”

## Displaying a Still Picture Stored in the “Memory Stick”

- 1 Insert the “Memory Stick” into the Memory Stick slot.

Insert it in the arrow mark direction with the mark faced upward.

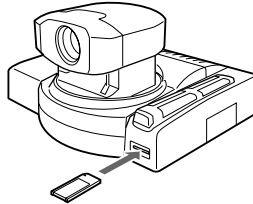

- 2 Open the Memory Stick menu.

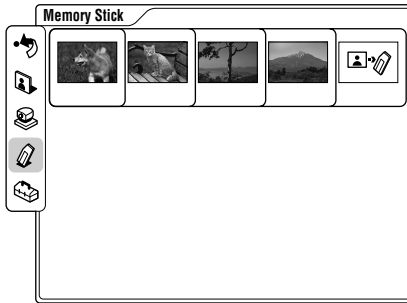

- 3 Select the desired still picture with the joystick on the Remote Commander, then press the joystick.

The sub-menu is opened.

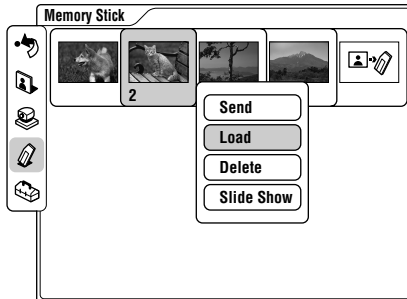

- 4 Select Load with the joystick on the Remote Commander, then press the joystick.

The menu disappears from the monitor screen and the selected still picture is displayed.

**To send a still picture**

Select Send with the joystick on the Remote Commander, then press the joystick. The selected picture will be sent.

**To delete a still picture**

Select Delete with the joystick on the Remote Commander, then press the joystick. The selected picture will be deleted.

**To view still pictures continuously with the slide show function**

Select Slide Show with the joystick on the Remote Commander, then press the joystick. The slide show starts from the selected still picture. The indication  appears on the monitor screen while in the slide show.

Move the joystick to the right, the next picture is displayed, and move the joystick to the left, the previous picture is displayed.

**To select the still picture**

Press the joystick on the Remote Commander while in the slide show, the sub-menu appears. Move the joystick on the Remote Commander to the right or left to select the desired picture, then press the joystick.



During communication, the still picture will be sent to the remote terminal, and not during communication, the still picture is displayed full-screen.

### **To stop the slide show**

When the sub-menu is displayed, select Cancel with the joystick on the Remote Commander, then press the joystick. When the sub-menu is not displayed, press the RETURN button on the Remote Commander.

### **If an unformatted “Memory Stick” is inserted**

The message “Format a Memory Stick?” will appear. When you format the “Memory Stick,” select OK. When you do not format it, select Cancel.

---

### **To eject the “Memory Stick”**

Push the “Memory Stick” inward, then release your finger. The “Memory Stick” comes out a little.

## **Notes on a “Memory Stick”**

### **On file names**

The file will be stored under the directory “\DCIM\100MSDCF” and its file name format is as follows: “DSCXXXXX.JPG”.

### **The usable file format of the still picture**

The Compact Processor does not correspond to progressive JPEG.

### **The compression format**

The Compact Processor compresses the data in the JPEG format. The file extension is “.jpg”.

### **A “Memory Stick” formatted by a computer**

A “Memory Stick” formatted by a computer does not have a guaranteed compatibility with the Compact Processor. Format the “Memory Stick” using a digital still camera or the Compact Processor.

### To format a “Memory Stick”

Select Memory Stick Format with the joystick on the Remote Commander in the General Setup menu, then select OK. The “Memory Stick” will be formatted. However, the still pictures and Phone Book list stored in the “Memory Stick” will be also deleted.

“Memory Stick” and  are trademarks of Sony Corporation.

## Clearing the Still Picture From the Screen

When the still picture is displayed, press the joystick on the Remote Commander.

## Saving a still image

Move the cursor to the last thumbnail, the one used to save images to the “Memory Stick,” on the “Memory Stick” menu using the joystick on the Remote Commander, then press the joystick down.

The still image currently displayed will be saved in the “Memory Stick.”

You can also save still images using the [Save] on the Still Image menu, or the [Save] on the submenu when you are on-line.

*For more details on saving a still image in a “Memory Stick,” see page 73.*

# Sending Still Pictures

When you send pictures that contain lots of text, we recommend you to send that picture as a still picture. Since still pictures are more clear than moving pictures for reading text. You can send a video as a still picture of external equipment connected to the the Compact Processor, or of the camera. You can also send pictures continuously.

## Sending One Still Picture

- 1 Open the Still Image menu.
- 2 Select Send with the joystick on the Remote Commander, then press the joystick, or press the STILL IMAGE button.

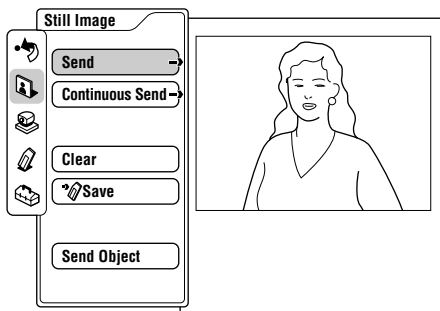

The moving picture on the monitor screen is frozen, and the still picture is sent. After the transmission, the message “Transmission of the still picture is completed” appears.

- 3 Set up the angle and zoom if you readjust them.

*For details on the angle and zoom settings, see “Adjusting the Camera Angle and Zoom” on page 57.*

### To clear the still picture from the screen

Select Clear with the joystick on the Remote Commander, then press the joystick.

**Tip**

You can also clear the still picture by pressing the FAR/NEAR button on the Remote Commander.

You can also clear the still image using the [Clear] item on the submenu when you are on-line, or by pressing the STILL IMAGE button on the Remote Commander twice.

## Sending Still Pictures Continuously

- 1 Open the Still Image menu.
- 2 Select Continuous Send with the joystick on the Remote Commander, then press the joystick, or press the STILL IMAGE button.

The moving picture on the monitor screen is frozen, and the still picture is continuously sent.

- 3 Set up the angle and zoom if you readjust them.

*For details on the angle and zoom settings, see “Adjusting the Camera Angle and Zoom” on page 57.*

### To cancel sending still pictures

Select Stop with the joystick on the Remote Commander, then press the joystick.

**Note**

The interval that takes to send the next still picture depends on the transfer rate.

## Sending Still Pictures of the Object Camera

- 1 Open the Still Image menu.
- 2 Select Send Object with the joystick on the Remote Commander, then press the joystick, or press the STILL IMAGE button.

The moving picture of the object camera is frozen, and the still picture is sent. After the still picture is sent, the moving picture of the object camera is displayed again.

## Sending a Still Picture Stored in the “Memory Stick”

- 1 Open the Memory Stick menu.
- 2 Select the desired still picture with the joystick on the Remote Commander, then press the joystick.

The sub-menu is opened.

- 3 Select Send with the joystick on the Remote Commander, then press the joystick.

The selected still picture is displayed and it is sent. After the transmission, the message “Transmission of the still picture is completed” appears.

### When you select Slide Show

Select Slide Show with the joystick on the Remote Commander, then press the joystick. The slide show starts from the selected still picture and these still pictures are sent to the remote terminal continuously.

*For details on the slide show, see pages 67 to 68.*

#### Note

Create the directory “\DCIM\100MSDCF” for the “Memory Stick,” and store the file under that directory. The file format must be as follows: “NNNnnnnn.JPG” (N = alphabet, n = number).

## Clearing the Still Picture From the Screen

Open the Still Image menu, and select Stop with the joystick on the Remote Commander, then press the joystick.

#### Tip

You can also cancel the sending of the still picture by pressing the FAR/NEAR button on the Remote Commander.

# Saving a Still Picture Into the “Memory Stick”

- 1 Display a moving picture.
- 2 Insert the “Memory Stick” into the Memory Stick slot.
- 3 Open the Still Image menu.
- 4 Select Save with the joystick on the Remote Commander, then press the joystick.

The selected moving picture is frozen and it is stored into the “Memory Stick.”

## Note

Do not remove the “Memory Stick” until the data is stored. The “Memory Stick” may be broken, or the Compact Processor may cause a malfunction.

## When the write-protect tab on the “Memory Stick” is set to LOCK

The message appears, and you cannot store a still picture into the “Memory Stick.”

## When the capacity of the “Memory Stick” is full

The message appears, and you cannot store a still picture into the “Memory Stick.”

## When an unformatted “Memory Stick” is inserted

The message “Format a Memory Stick?” appears. When you format the “Memory Stick,” select OK, when you do not format it, select Cancel.

## Note

A file is saved as a new file.

## Tip

You can select a moving picture sent from the remote terminal using the FAR/NEAR button on the Remote Commander, and store it in the “Memory Stick.”

# Saving a Still Picture Into the “Memory Stick”

## Saving with the “Memory Stick” menu

You can save still images using the “Memory Stick” menu screen displaying the thumbnails saved in the “Memory Stick” whether you are on-line or not.



- 1** Open the “Memory Stick” menu with the joystick on the Remote Commander to display the image.
- 2** Move the cursor to the last thumbnail, the one used to save images to the “Memory Stick,” on the “Memory Stick” menu using the joystick on the Remote Commander, then press the joystick down.

The still image displayed will be saved in the “Memory Stick.”

When there is no still image displayed, either of the following will be saved when you are on-line.

- your own or the remote party’s images.

When you are not on-line, your own images will be saved.

---

## Saving with the on-line submenu

Press the joystick down while on-line and a submenu appears. When you select Save and press the joystick down again, the still image will be saved.

*For details on the On-line submenu, see page 75.*

# Sending the Dial Tone to the Remote Party

You can send the dial tone (Dual Tone Multi Frequency) assigned to the 0 – 9, #, and \* buttons on the Remote Commander to control the remote system.

- 1 Press the \* button on the Remote Commander.

The DTMF menu appears on the monitor screen.

- 2 Press one of the number buttons (0 – 9, #, and \*) that will be sent to the remote system.

The dial tone will be sent to the remote system.

- 3 To stop sending the dial tone, press the joystick on the Remote Commander.

The DTMF menu disappears from the monitor screen.

---

## The On-line submenu

Press the joystick on the Remote Commander down while on-line and a submenu appears.

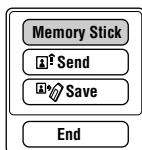

**“Memory Stick”:** Press this button to go to the “Memory Stick” menu.

**Send:** Press this button to send one still image. When a still image is displayed, Cancel is displayed, and you can cancel the sending of the image with the joystick on the Remote Commander.

**Save:** Press this button to save the still image in the “Memory Stick.”

*For details on Save, see page 74.*

# Ending a Meeting

Press the CONNECT/DISCONNECT () button on the Remote Commander.  
The message appears on the monitor screen.

## To disconnect the call

Select OK with the joystick on the Remote Commander, then press the joystick. Or press the CONNECT/DISCONNECT () button on the Remote Commander again.

### Note

The Compact Processor remains on even if the connection is broken.

## To continue your meeting

Select Cancel with the joystick on the Remote Commander, then press the joystick.

---

## Registering a connected remote party in the Phone Book

When the [Auto List Registration] item on the third page of the General Setup menu (page 111) is set to ON, but the remote parties are not registered after the conference, the “Register this participant in the list?” dialog box appears. When you choose OK, the Edit List registration menu appears.

### Note

When this item is set to OFF, the dialog box does not appear.

# Advanced Operation

## Connecting With an MCU

You can perform a multiple communication with making a connection to an MCU (Multipoint Control Unit). Once you connect with the MCU that has the chair control function, the chair control is activated among 99 terminals.

### Note

When you have upgraded the system using the optional PCS-UC161 Upgrade Kit and using a LAN, the chair control is deactivated.

- 1** Connect to an MCU.
- 2** Press the FAR/NEAR button on the Remote Commander.

The Display Control menu appears on the monitor screen.

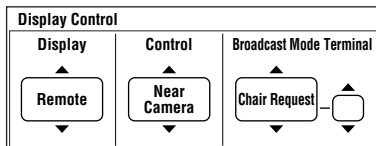

**Broadcast Mode:** Selects the broadcast mode.

**Terminal:** Selects the terminal number from 1 to 99.

When a terminal is selected, its terminal name is displayed.

(Continued)

- 3 Select Chair Request from Broadcast Mode with the joystick on the Remote Commander.

**Note**

When you do an incapable operation, the indication “Command is rejected by MCU” appears on the monitor screen.

---

## To see a picture of the selected terminal

- 1 Select Receive from Broadcast Mode with the joystick on the Remote Commander.
- 2 Select the terminal number with the joystick moving up or down, then press the joystick.

The picture of the selected terminal appears on the local monitor.

**Note**

When you have not selected the terminal number, a terminal which has the lowest number is first selected.





---

## To broadcast a picture of the selected terminal to all the terminals

- 1** Select Broadcast from Broadcast Mode with the joystick on the Remote Commander.
- 2** Select the terminal number with the joystick moving up or down, then press the joystick.

A picture of the selected terminal appears on your monitor and it is broadcast to all terminals.

---

## To broadcast a picture of your terminal to all the terminals

- 1** Select Broadcast from Broadcast Mode with the joystick on the Remote Commander.
- 2** Select 0 with the joystick moving up or down, then press the joystick.

A picture on your monitor is broadcast to all the terminals. The indication  appears on the monitor screen when you broadcast.

---

## To end the chair control

Press the FAR/NEAR button on the Remote Commander. Select Release from Broadcast Mode with the joystick on the Remote Commander, then press the joystick.

The system can connect to a normal phone to hold a meeting using the sound only. **(Voice Meeting)**

The basic procedure is same as one with images and sound.

### Note

When you have upgraded the system using the optional PCS-UC161 Upgrade Kit and using a LAN, you cannot do the voice meeting.

---

## To start a voice meeting with unregistered remote parties

Set Line I/F to ISDN (Telephone) in the Manual Dial menu.

*For details on the setting, see “Calling an Unregistered Remote Party” on page 42.*

The indication “VOICE ONLY” appears on the monitor screen, and the local picture is displayed on the local monitor screen.

---

## To register remote parties for holding a voice meeting

Set Line I/F to ISDN (Telephone) in the List Edit menu.

*For details on the registration, see “Registering a Remote Party” on page 81.*

---

## To set the audio protocol

Set up the Telephone Mode item in the Dial Setup menu. When you call, set Telephone to Auto. This automatically sets to G.711  $\mu$ -law (NTSC); to G.711 a-law (PAL). When the voice meeting starts from the remote terminal, the audio protocol setting is not required.

*For details on the setup, see “Dial Setup Menu” on page 100.*

# *Registration and Setup*

## Registering a Remote Party

You can register a remote party before making the connection. You can register up to 500 remote parties. You can also store an image, such as a facial portrait, in each index list.

### **Notes**

- Register the information in the boxes B1 to C2 when you have installed the optional PCS-I160 BRI Board to use three ISDN lines.
- Meetings on a LAN are only available when the system has been upgraded with the optional PCS-UC161 Upgrade Kit.

# Registering a Remote Party

## Making an Entry

- 1 Press the PHONE BOOK button on the Remote Commander.

The Phone Book menu appears on the monitor screen.

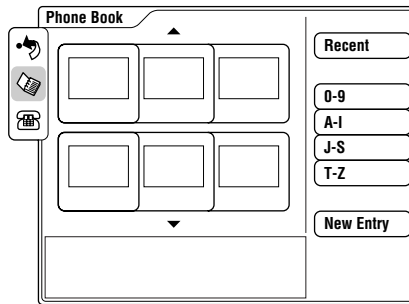

- 2 Select New Entry with the joystick on the Remote Commander, then press the joystick.

The List Edit menu appears on the monitor screen.

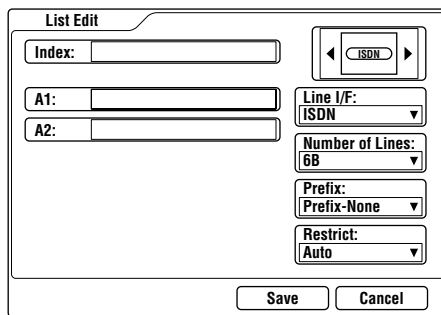

- 3 Register the name of the remote party into the Index box.

*For details on how to input, see “Entering Characters” on page 39.*

## 4 Set up the line interface.

**ISDN:** Connects to a TV conferencing system via the normal ISDN line.

**ISDN (Telephone):** Connects to a phone to have a voice meeting via the normal ISDN line.

**V.35:** Connects to a TV conferencing system via the V.35 interface. (Option)

**LAN:** Connects to a TV conferencing system using a LAN. (Option)

**ISDN:** Sets up a Multipoint connection over an ISDN line. (Optional)

## 5 When selecting other than LAN in step 4

Enter the telephone number and the sub-address for the remote party (if the remote party set a sub-address) in the A1 and A2 boxes.

If the remote party has multiple telephone numbers, enter the first number in the A1 box and the second number in the A2 box.

Enter the asterisk (\*) after the telephone number, then enter the sub-address. You cannot use the alphabet in a sub-address.

### When you connect with more than 2B channels

You have to register the data in the data entry boxes for items B1 to C2. Select the data entry boxes for telephone numbers B1 to C2 with the joystick on the Remote Commander, then register the telephone numbers for the remote parties (when sub-addresses have been set, register the sub-addresses, too).

The screenshot shows a dialog box titled "List Edit". It has the following elements:

- Index:** A text input field.
- A1:** A text input field.
- A2:** A text input field.
- B1:** A text input field.
- B2:** A text input field.
- C1:** A text input field.
- C2:** A text input field.
- Line I/F:** A dropdown menu currently showing "ISDN".
- Number of Lines:** A dropdown menu currently showing "6B".
- Prefix:** A dropdown menu currently showing "Prefix-None".
- Restrict:** A dropdown menu currently showing "Auto".
- Buttons:** "Save" and "Cancel" buttons at the bottom.

(Continued)

## When selecting LAN in step 4

Enter the IP address (or the host name and domain name) of the remote party.

- 6** Select the line interface icons or still images stored in the “Memory Stick.”



Move the joystick to the left or right to select the icon or still image, then press the joystick.

### Note

If the “Memory Stick” which has still images is not inserted, you cannot select still images.

## To set the number of lines to be connected for an ISDN call

If you are using an ISDN line, you can select the number of lines to be used when you receive an ISDN call. Select [Number of ISDN Lines to be used] with the joystick on the Remote Commander, then press the joystick down.

Set the number of lines by moving the joystick up or down.

- 1B:** Connects via 1B channel.
- 2B:** Connects via 2B channels.
- 3B:** Connects via 3B channels.
- 4B:** Connects via 4B channels.
- 5B:** Connects via 5B channels.
- 6B:** Connects via 6B channels.

### To select the LAN bandwidth to be used

When you are using a LAN, you can select the bandwidth to be used from among the settings below.

64 Kbps, 128 Kbps, 384 Kbps, 512 Kbps, 768 Kbps, 1024 Kbps, Other

When you choose “Other,” you must enter the value yourself. Bandwidths from 1 to 1024 Kbps can be entered.

## 7 Select the prefix number setting.

**None:** Does not use the prefix number.

**Prefix-A:** Uses the setting A set in the Dial Setup menu.

**Prefix-B:** Uses the setting B set in the Dial Setup menu.

**Prefix-C:** Uses the setting C set in the Dial Setup menu.

*For details on setting the prefix number, see “Dial Setup Menu” on page 100.*

### Tip

You can verify the setup of Prefix by pressing the HELP button on the Remote Commander.

## 8 Select the ISDN transfer rate.

**Auto:** Connects to a remote party with a normal ISDN line.

**56K:** Connects to a region or country with a 56 Kbps ISDN transfer rate.

## 9 Select Save with the joystick on the Remote Commander, then press the joystick.

The registration is complete.

### Notes

- When using the Compact Processor as the MCU, item below cannot be set up:  
Number of Lines, Restrict.
- When using a LAN, item below cannot be set up:  
Restrict.

# Registering a Remote Party

## To set up other items than the items above

When More Options Enable is set to On in the Dial Setup menu, the More Options button is displayed at the lower part of the menu. Select More Options with the joystick on the Remote Commander, then press the joystick. The Dial Setup menu appears and you can set up the other items.

### Notes

- The setup of More Options is given priority to the setup in the Dial Setup menu.
- When the Compact Processor is used in Multipoint mode, up to three locations for each remote party can be registered in one list. For details, see page 131.

## Modifying an Entry

You can modify the name and telephone numbers of an entry.

- 1** Select the Index title to be modified with the joystick, then press the joystick.
- 2** Select Edit with the joystick on the Remote Commander, then press the joystick.

The List Edit menu appears.

- 3** Modify the entry.
- 4** Select Save with the joystick on the Remote Commander, then press the joystick.

The entry is modified.

## Deleting Registered Entries

You can delete a registered entry as follows.

- 1** Select the Index title to be deleted with the joystick on the Remote Commander.
- 2** Select Delete with the joystick on the Remote Commander, then press the joystick.

The indication “Delete list?” appears on the monitor screen.

- 3** Select OK with the joystick on the Remote Commander, then press the joystick.

The selected Index entry is deleted.

---

### To cancel deleting

Select Cancel with the joystick on the Remote Commander in step **3**, then press the joystick.

## Duplicating the Setting of the Phone Book Menu

- 1** Select the index to be copied with the joystick on the Remote Commander, then press the joystick.
- 2** Select Copy with the joystick on the Remote Commander, then press the joystick.

The index is duplicated, and “XXX-2” appears in the Index box. Since the setting has been duplicated, you can use it with a little modification.

## Notes on Registration

### General note

If the Restrict setting of the remote party is set to 56K in the Answer Setup menu, the connection will be made at 56 Kbps even if you set Restrict to Auto in the Dial Setup menu.

### Note on the optional PCS-I160 BRI Board

If you have installed the optional PCS-I160 BRI Board, you can use three ISDN lines (up to 6B channels). In this case, register second telephone number in the B1 and B2 boxes, and third telephone number in the C1 and C2 boxes.

### Note on the optional PCS-I161 V.35 Board

If the optional PCS-I161 V.35 Board has been installed and connected to a private line or a terminal adaptor via the V.35 interface, select V.35 in Line I/F, then enter as follows:

- When not using RS-366, set V.35 RS-366 to Off in the Dial Setup menu. Do not enter the telephone numbers.
- When using RS-366, set V.35 RS-366 to On in the Dial Setup menu. Enter the telephone numbers.





### To change the ISDN transfer rate temporarily

The Compact Processor is set to 64 Kbps for an ISDN line at factory. However, some countries (e.g., the USA) or regions may have 64 Kbps and 56 Kbps ISDN transfer rates. If the remote party has set its transfer rate to 56 Kbps, you need to set your system to 56 Kbps to communicate with that system. Before making a call to such a party, set Restrict to 56K in the Dial Setup menu.

# Registering Local Information

Before holding a meeting, you will need to register your local information on the ISDN Setup menu, such as the local directory number.

## Setting Up the ISDN Setup Menu

- 1 Select     with the joystick on the Remote Commander in the launcher menu, then press the joystick, or press the MENU button.

The Setup menu appears on the monitor screen.

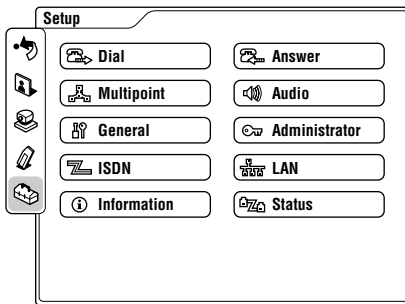

- 2 Select ISDN with the joystick on the Remote Commander, then press the joystick.

The ISDN Setup menu (Page 1) appears on the monitor screen.

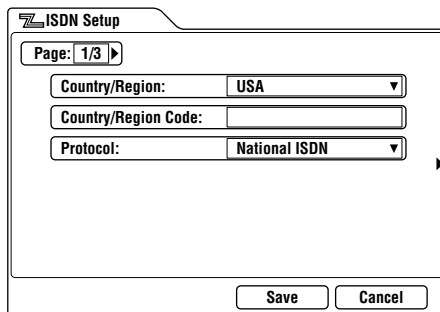

- 3 Select your country or region with the joystick, then press the joystick.

*(Continued)*

# Registering Local Information

- 4 Enter your country code or region code in the Country/Region Code box.

(e.g., enter “1” for the USA.)

- 5 Select Page 1/3 with the joystick on the Remote Commander, then move the joystick to the right.

The ISDN Setup menu (Page 2) appears on the monitor screen.

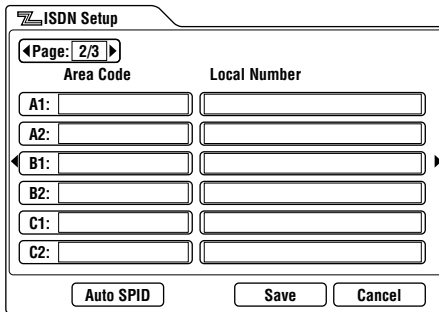

- 6 Enter your area code in the Area Code boxes A1 and A2.

Do not enter the first zero number of your area code. (e.g., enter only “408” for California.)

**Note**

Register information in the boxes B1 to C2 if you have installed the optional PCS-I160 BRI Board.

- 7 Enter your telephone number and sub-address (if you set your sub-address) in the Local Number boxes A1 and A2.

Enter the asterisk (\*) after the telephone number, then enter the sub-address. You cannot use the alphabet in a sub-address.

- 8 Select Page 2/3 with the joystick on the Remote Commander, then move the joystick to the right.

The ISDN Setup (SPID) menu (Page 3) appears on the monitor screen. (This is only for the USA and Canada.)



- 
- 9** Set up the ISDN Setup (SPID) menu. (This is only for the USA and Canada.)

*For details on the SPID registration, see “SPID Registration for Customers in the USA” on page 92.*

- 10** Select Save with the joystick on the Remote Commander, then press the joystick.

The message for verification appears.

- 11** Select OK with the joystick on the Remote Commander, then press the joystick.

The setting is saved.

**To cancel the setup**

Select Cancel with the joystick on the Remote Commander, then press the joystick. Or press the RETURN button on the Remote Commander.

**To page up or down the menu**

Move the joystick on the Remote Commander to the right or left.

# SPID Registration for Customers in the USA

If the system is connected to a network switch of the following types, you can use ISDN lines.

- **Network switch type:** AT&T 5ESS  
**Network switch software version:** 5E8 or later (for National ISDN-1 and National ISDN-2)
- **Network switch type:** Northern Telecom (NTI) DMS-100  
**Network switch software version:** BCS34 or later (for National ISDN-1 and National ISDN-2)
- **Network switch type:** AT&T 5ESS  
**Network switch software version:** 5E8 or later (for Multipoint or Point-to-Point Custom ISDN)
- **Network switch type:** Northern Telecom (NTI) DMS-100  
**Network switch software version:** BCS34 or later (for Custom ISDN)

In these cases, you shall register the LDN (Local Directory Number: seven-digit local phone number).

Follow the steps below to register the LDN(s).

- 1 Open the ISDN Setup menu (Page 1).

The screenshot shows a dialog box titled "ISDN Setup" with a page indicator "Page: 2/3". The dialog contains a table with two columns: "Area Code" and "Local Number". There are six rows of input fields, labeled A1, A2, B1, B2, C1, and C2. The B1 row has a left arrow and a right arrow next to its input fields. At the bottom of the dialog are three buttons: "Auto SPID", "Save", and "Cancel".

	Area Code	Local Number
A1:	<input type="text"/>	<input type="text"/>
A2:	<input type="text"/>	<input type="text"/>
B1:	<input type="text"/>	<input type="text"/>
B2:	<input type="text"/>	<input type="text"/>
C1:	<input type="text"/>	<input type="text"/>
C2:	<input type="text"/>	<input type="text"/>

Auto SPID Save Cancel

---

**2** Enter your country code in the Country Code box.

If the network switch type is AT&T 5ESS (National ISDN)  
or NTI DMS-100 (National ISDN)

Country Code is “1”

If the network switch type is AT&T 5ESS (Multipoint  
Custom ISDN)

Country Code is “1\*10”

If the network switch type is AT&T 5ESS (Point-to-Point  
Custom ISDN)

Country Code is “1\*12”

If the network switch type is NTI DMS-100 (Custom  
ISDN)

Country Code is “1\*11”

**3** Open the ISDN Setup menu (Page 2).

**4** Enter your LDN (s) and sub-address in the Local Number  
boxes.

If one ISDN line is used, register the LDN in the boxes A1  
and A2.

If two ISDN lines are used, register the LDNs in the boxes  
A1, A2, B1, B2.

If three ISDN lines are used, register the LDNs in the  
boxes A1, A2, B1, B2, C1, C2.

If the network switch type is AT&T 5ESS (National ISDN)  
Each LDN is given for three channels (CH A1 and A2, CH  
B1 and B2, CH C1 and C2)

or

Each LDN is different as a separate LDN is given for each  
channel.

The following shows the use of three ISDN lines for  
AT&T 5ESS (National ISDN).

In case of each LDN is given for two channels.

# SPID Registration for Customers in the USA

ISDN Setup

Page: 2/3

Area Code	Local Number
A1: 408	9876532
A2: 408	9876532
B1: 408	9871356
B2: 408	9871356
C1: 408	9852464
C2: 408	9852464

Auto SPID Save Cancel

In case of each LDN is different as a separate LDN is given for each channel.

ISDN Setup

Page: 2/3

Area Code	Local Number
A1: 408	9876543
A2: 408	9876544
B1: 408	9871234
B2: 408	9871235
C1: 408	9852468
C2: 408	9852469

Auto SPID Save Cancel

If the network switch type is AT&T 5ESS (Multipoint or Point-to-Point Custom ISDN)  
Each LDN is given for three channels (CH A1 and A2, CH B1 and B2, CH C1 and C2).

The following shows the use of three ISDN lines for AT&T 5ESS (Multipoint Custom ISDN).

ISDN Setup

Page: 2/3

Area Code	Local Number
A1: 408	9876532
A2: 408	9876532
B1: 408	9871356
B2: 408	9871356
C1: 408	9852464
C2: 408	9852464

Auto SPID Save Cancel

The following shows the use of three ISDN lines for AT&T 5ESS (Point-to-Point Custom ISDN).

	Area Code	Local Number
A1:	408	9876532
A2:	408	9876532
B1:	408	9871356
B2:	408	9871356
C1:	408	9852464
C2:	408	9852464

If the network switch type is NTI DMS-100 (National ISDN or Custom ISDN)  
Each LDN is different as a separate LDN is given for each channel.

The following shows the use of three ISDN lines for NTI DMS-100 (National ISDN).

	Area Code	Local Number
A1:	408	9876543
A2:	408	9876544
B1:	408	9871234
B2:	408	9871235
C1:	408	9852468
C2:	408	9852469

The following shows the use of three ISDN lines for NTI DMS-100 (Custom ISDN).

	Area Code	Local Number
A1:	408	9876543
A2:	408	9876544
B1:	408	9871234
B2:	408	9871235
C1:	408	9852468
C2:	408	9852469

(Continued)

## 5 Open the ISDN Setup (SPID) menu (Page 3).

SPID in the ISDN Setup (SPID) menu and the Local Number in the ISDN Setup menu (Page 2) are entered in pairs and should not be crossed with BRI channels as each has its own LDN.

Be sure to enter each number in pairs. If it is crossed, you must correct the SPID-LDN pairs.

If the network switch type is AT&T 5ESS (National ISDN) The following shows the use of three ISDN lines. In case of each LDN is given for two channels.

ISDN Setup  
Page: 2/3

Area Code	Local Number
A1: 408	9876532
A2: 408	9876532
B1: 408	9871356
B2: 408	9871356
C1: 408	9852464
C2: 408	9852464

Auto SPID Save Cancel

ISDN Setup  
Page: 3/3

SPID

A1: 019876532001
A2:
B1: 019871356001
B2:
C1: 019852464001
C2:

Save Cancel

In case of each LDN is different as a separate LDN is given for each channel.

ISDN Setup  
Page: 2/3

Area Code	Local Number
A1: 408	9876543
A2: 408	9876544
B1: 408	9871234
B2: 408	9871235
C1: 408	9852468
C2: 408	9852469

Auto SPID Save Cancel

ISDN Setup  
Page: 3/3

SPID

A1: 019876543001
A2: 019876544001
B1: 019871234001
B2: 019871235001
C1: 019852468001
C2: 019852469001

Save Cancel

If the network switch type is AT&T 5ESS (Multipoint Custom ISDN)

The following shows the use of three ISDN lines.

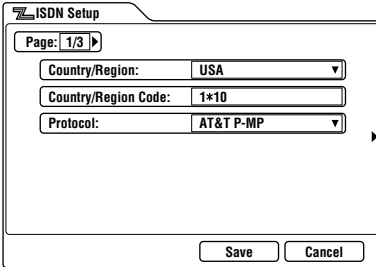

ISDN Setup

Page: 1/3

Country/Region: USA

Country/Region Code: 1\*10

Protocol: AT&T P-MP

Save Cancel

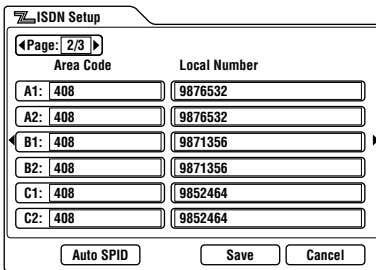

ISDN Setup

Page: 2/3

Area Code	Local Number
A1: 408	9876532
A2: 408	9876532
B1: 408	9871356
B2: 408	9871356
C1: 408	9852464
C2: 408	9852464

Auto SPID Save Cancel

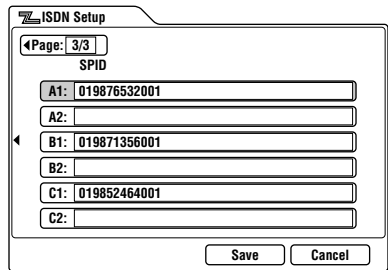

ISDN Setup

Page: 3/3

SPID

A1: 019876532001

A2:

B1: 019871356001

B2:

C1: 019852464001

C2:

Save Cancel

If the network switch type is AT&T 5ESS (Point-to-Point Custom ISDN)

You do not have to enter SPID.

The following shows the use of three ISDN lines.

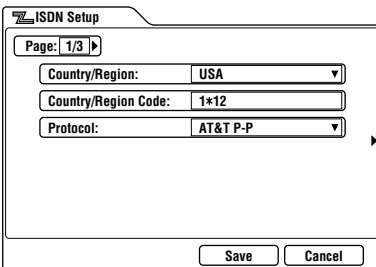

ISDN Setup

Page: 1/3

Country/Region: USA

Country/Region Code: 1\*12

Protocol: AT&T P-P

Save Cancel

(Continued)

# SPID Registration for Customers in the USA

ISDN Setup

Page: 2/3

Area Code	Local Number
A1: 408	9876532
A2: 408	9876532
B1: 408	9871356
B2: 408	9871356
C1: 408	9852464
C2: 408	9852464

Auto SPID Save Cancel

ISDN Setup

Page: 3/3

SPID

A1:
A2:
B1:
B2:
C1:
C2:

Save Cancel

If the network switch type is NTI DMS-100 (National ISDN)  
The following shows the use of three ISDN lines.

ISDN Setup

Page: 2/3

Area Code	Local Number
A1: 408	9876543
A2: 408	9876544
B1: 408	9871234
B2: 408	9871235
C1: 408	9852468
C2: 408	9852469

Auto SPID Save Cancel

ISDN Setup

Page: 3/3

SPID

A1: 019876543001
A2: 019876544001
B1: 019871234001
B2: 019871235001
C1: 019852468001
C2: 019852469001

Save Cancel

If the network switch type is NTI DMS-100 (Custom ISDN)  
The following shows the use of three ISDN lines.

ISDN Setup

Page: 1/3

Country/Region:	USA
Country/Region Code:	1*11
Protocol:	Northern Telecom

Save Cancel

ISDN Setup

Page: 2/3

Area Code	Local Number
A1: 408	9876543
A2: 408	9876544
B1: 408	9871234
B2: 408	9871235
C1: 408	9852468
C2: 408	9852469

Auto SPID Save Cancel

ISDN Setup

Page: 3/3

SPID

A1: 019876543001
A2: 019876544001
B1: 019871234001
B2: 019871235001
C1: 019852468001
C2: 019852469001

Save Cancel

You should let the remote party user know the contents of your LDN. The remote party dial list and the LDN should be kept in pairs.

The following shows a setup using three ISDN lines.

ISDN Setup

Page: 2/3

Area Code	Local Number
A1: 408	9876543
A2: 408	9876544
B1: 408	9871234
B2: 408	9871235
C1: 408	9852468
C2: 408	9852469

Auto SPID Save Cancel

ISDN Setup

Page: 3/3

SPID

A1: 913219876543
A2: 913219876544
B1: 913219871234
B2: 913219871235
C1: 913219852468
C2: 913219852469

Save Cancel

- 6 Select Save with the joystick on the Remote Commander, then press the joystick.
- 7 Select OK with the joystick on the Remote Commander, then press the joystick.

The registration is complete.

(Continued)

# Menu Items in the Setup Menu

## Dial Setup Menu

Sets up the attribute for calling.

Page 1

The screenshot shows a window titled "Dial Setup" with a "Page: 1/4" indicator. It contains six dropdown menus and two buttons at the bottom. The settings are as follows:

Field	Value
Line I/F:	ISDN
Bonding:	Auto
Number of Lines:	6B
LAN Bandwidth:	1024Kbps
Prefix:	Prefix-None
Restrict:	Auto

Buttons: Save, Cancel

**Line I/F:** Selects the line interface.

**ISDN:** Connects to a TV conferencing system via the normal ISDN line.

**ISDN (Telephone):** Connects to a phone to have a voice meeting via the normal ISDN line.

**V.35:** Connects to a TV conferencing system via the V.35 interface. (Option)

**LAN:** Connects to a TV conferencing system using a LAN. (Option)

**ISDN:** Sets up a Multipoint connection over an ISDN line. (Optional)

**Bonding:** Selects whether to use the Inverse Multiplexer interface or not.

“Bonding (Bandwidth on Demand Interoperability Group)” is a trademark of THE BONDING CONSORTIUM.

**Auto:** Normally, select this setting.

**On:** Connects to a remote party via the Inverse Multiplexer interface.

**Number of Lines:** Selects the number of lines usable for BONDING calling.

**1B:** Connects via 1B channel.

**2B:** Connects via 2B channels.

**3B:** Connects via 3B channels.

**4B:** Connects via 4B channels.

**5B:** Connects via 5B channels.

**6B:** Connects via 6B channels.

- LAN Bandwidth:** Sets the bandwidth to be used when connected to a LAN. When [Other] is selected, bandwidth values between 1 and 1024K can be entered.
- Prefix:** Selects the prefix number setting from the following.
- None:** Does not use the prefix number.
  - Prefix-A:** Uses the setting A set in the Dial Setup menu.
  - Prefix-B:** Uses the setting B set in the Dial Setup menu.
  - Prefix-C:** Uses the setting C set in the Dial Setup menu.
- Restrict:** Selects the transfer rate via the ISDN line.
- Auto:** Normally, select this setting.
  - 56K:** Selects this setting when you call a region or country via the 56 Kbps transfer rate.

*For details on setting the prefix, see page 103.*

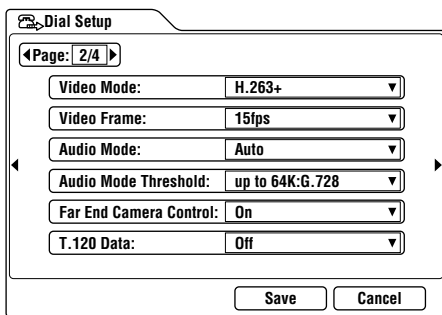

- Video Mode:** Selects the protocol for the video encoding.
- H.261:** Sends pictures based on Recommendation H.261 (When sending pictures using Annex D).
  - H.263+:** Sends pictures based on Recommendation H.263. When the remote party's equipment also supports H.263+, and the following conditions are met: H.263, 15 fps, and less than 384 Kbps, an H.263+ (H.263 Annex-J) connection can be established.
- Video Frame:** Selects the number of frames.
- 15fps:** Sends pictures at a maximum rate of 15 frames per second.
  - 30fps:** Sends pictures at a maximum rate of 30 frames per second.

**Audio Mode:** Selects the protocol for the audio encoding.

**G.728:** The audio bandwidth is narrow but the image quality is better. (G.728: 3.4 kHz)

**G.722:** The audio bandwidth is wider for better sound quality. (7 kHz)

**G.711:** Select this setting when the remote system does not support neither G.722 nor G.728.

**Auto:** Automatically selects the audio encoding according to the number of used lines.

**Audio Mode Threshold:** Selects the setup of the Auto setting of Audio Mode.

**up to 64K:G.728:** Sets the Auto setting of Audio Mode to G.728 when the used-line is 1B channel and sets to G.722 when it is 2B channels or more.

**up to 128K:G.728:** Sets the Auto setting of Audio Mode to G.728 when the used-line is 2B channels or less and sets to G.722 when it is 3B channels or more.

**up to 192K:G.728:** Sets the Auto setting of Audio Mode to G.728 when the used-line is 3B channels or less and sets to G.722 when it is 4B channels or more.

**Far End Camera Control:** Selects whether to control the far end camera or not.

**On:** Operates the far end camera.

**Off:** Does not operate the far end camera.

**T.120 Data:** Selects whether to have a T.120 data meeting.

**On:** Holds a T.120 data meeting.

**Off:** Does not hold a T.120 data meeting.

### Notes

- When the optional V.35 Board is not installed, you cannot select V.35 from Line I/F.
- When the system is not upgraded using the optional PCS-UC161 Upgrade Kit, you cannot select LAN from Line I/F.

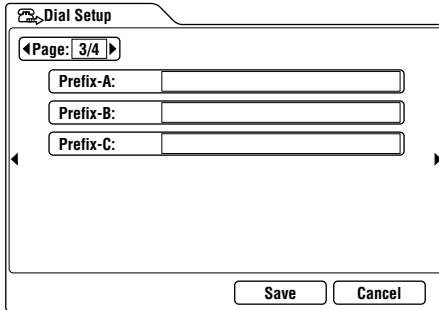

**Prefix-A:** Sets up a prefix number that will be registered for Prefix-A in the Dial Setup menu.

**Prefix-B:** Sets up a prefix number that will be registered for Prefix-B in the Dial Setup menu.

**Prefix-C:** Sets up a prefix number that will be registered for Prefix-C in the Dial Setup menu.

**Note**

The number input in these boxes above is automatically dialed before the telephone number is dialed.

Enter “9” when you have to dial nine to reach an outside line.

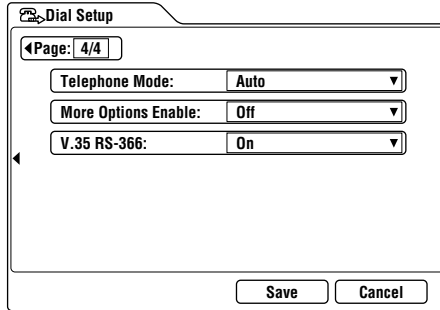

**Telephone Mode:** Selects the audio protocol for the voice meeting.

**Auto:** Selects the protocol automatically.

**G.711  $\mu$ -law:** Selects the  $\mu$ -law protocol.

**G.711 A-law:** Selects the A-law protocol.

**More Options Enable:** Selects whether to enable the dial attribute set in the Dial Setup menu for each dial list.

**On:** Enables the dial attribute for each dial list.

**Off:** Disables the dial attribute for each dial list.

**V.35 RS-366:** Selects whether to specify the telephone number when connecting via the V.35 interface.

**On:** When specifying the telephone number.

**Off:** When not specifying the telephone number.

**Note**

When the optional V.35 Board is not installed, V.35 RS-366 is not indicated.

## Answer Setup Menu

Sets up the communication items for receiving.

Page 1

The screenshot shows a window titled "Answer Setup" with a "Page: 1/2" indicator and a right arrow. It contains five dropdown menus:

Auto Answer:	On
Number of Lines:	6B
Restrict:	Auto
LAN Bandwidth:	1024Kbps
ISDN MSN:	Off

At the bottom of the window are "Save" and "Cancel" buttons.

**Auto Answer:** Selects the answer mode.

**On:** Answers calls in auto answer mode.

**Off:** Answers calls in manual answer mode.

**Number of Lines:** Selects the number of lines usable for receiving.

**1B:** Connects via 1B channel.

**2B:** Connects via 2B channels.

**3B:** Connects via 3B channels.

**4B:** Connects via 4B channels.

**5B:** Connects via 5B channels.

**6B:** Connects via 6B channels.

**Restrict:** Selects the transfer rate via the ISDN line.

**Auto:** Normally, select this setting.

**56K:** Selects this setting when you call a region or country via the 56 Kbps transfer rate.

**LAN Bandwidth:** Sets the bandwidth to be used when connected to a LAN. When Other is selected, bandwidth values between 1 and 1024K can be entered.

**ISDN MSN:** Selects whether you are using the Multiple Subscriber Number.

**On:** When you are using the Multiple Subscriber Number.

**Off:** When you are not using the Multiple Subscriber Number.

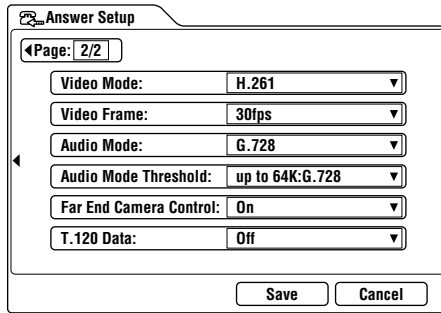

**Video Mode:** Selects the protocol for the video encoding.

**H.261:** Receives pictures based on Recommendation H.261.

**H.263+:** Receives pictures based on Recommendation H.263.

When the remote party's equipment also supports H.263+, and the following conditions are met: H.263, 15 fps, and less than 384 Kbps, an H.263+ (H.263 Annex-J) connection can be established.

**Video Frame:** Selects the number of frames.

**15fps:** Receives pictures at a maximum rate of 15 frames per second.

**30fps:** Receives pictures at a maximum rate of 30 frames per second.

**Audio Mode:** Selects the protocol for the audio encoding.

**G.728:** The audio bandwidth is narrow but the image quality is better. (G.728: 3.4 kHz)

**G.722:** The audio bandwidth is wider for better sound quality. (7 kHz)

**G.711:** Does not use G.722 and G.728.

**Auto:** Automatically selects the audio encoding according to the number of used lines.

**Audio Mode Threshold:** Selects the setup of the Auto setting of Audio Mode.

**up to 64K:G.728:** Sets the Auto setting of Audio Mode to G.728 when the used-line is 1B channel and sets to G.722 when it is 2B channels or more.

**up to 128K:G.728:** Sets the Auto setting of Audio Mode to G.728 when the used-line is 2B channels or less and sets to G.722 when it is 3B channels or more.

**up to 192K:G.728:** Sets the Auto setting of Audio Mode to G.728 when the used-line is 3B channels or more and sets to G.722 when it is 4B channels or more.

**Far End Camera Control:** Selects whether the near end camera is controlled or not.

**On:** Operates the near end camera.

**Off:** Does not operate the near end camera.

**T.120 Data:** Selects whether to have a T.120 data meeting.

**On:** Holds a T.120 data meeting.

**Off:** Does not hold a T.120 data meeting.

## Multipoint Setup Menu

When you have upgraded the system using the optional PCS-UC160 Upgrade Kit and hold an MCU conference, set up the Multipoint Setup menu.

**Note**

The Multipoint Setup menu is displayed only when the system has been upgraded using the optional PCS-UC160 Upgrade Kit.

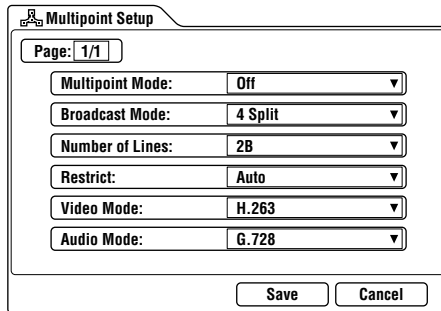

**Multipoint Mode:** Set to On when holding a point to multipoint meeting.

**On:** Holds a Point to multi-point meeting.

**Off:** Holds a normal meeting.

**Tip**

Using the launcher menu, you can also toggle Multipoint Mode between ON and OFF by holding the joystick on the Remote Commander all the way to the right.

**Broadcast Mode:** Selects the broadcast mode.

**4 Split:** Displays each party on the four-split screen.

**Voice Activated:** Detects the terminal that speaks at the highest level among the connected terminals, and sends the picture to all the terminals.

*(Continued)*

# Menu Items in the Setup Menu

**Number of Lines:** Selects the number of lines to be used.

**1B:** Connects via 1B-channel.

**2B:** Connects via 2B-channel.

**Restrict:** Selects the transfer rate via the ISDN line.

**Auto:** Connects to a remote party with a normal ISDN line.

**56K:** Selects this setting when you call a region or country via the 56 Kbps transfer rate.

**Video Mode:** Selects the protocol for the video encoding.

**H.261:** When connecting with the protocol based on H.261.

**H.263:** When connecting with the protocol based on H.263.

**Audio Mode:** Selects the protocol for the audio encoding.

**G.728:** The audio bandwidth is narrow but the image quality is better. (3.4 kHz)

**G.722:** The audio bandwidth is wider for better sound quality. (7 kHz)

**G.711:** When not using G.722 and G.728.

## Audio Setup Menu

Sets up the audio system.

The screenshot shows a window titled "Audio Setup" with a "Page: 1/1" indicator. It contains six rows of settings, each with a label and a dropdown menu:

Input Select:	MIC
Mic Select:	Internal
Lip Sync:	Off
Echo Canceler:	Internal
Beep Sound:	On
Recording Mute:	On

At the bottom of the window are two buttons: "Save" and "Cancel".

**Input Select:** Selects the audio input.

**MIC:** The microphone is selected.

**AUX:** The external equipment is selected.

**MIC+AUX:** Both the microphone and the external equipment are selected.

**Mic Select:** Selects the microphone to be used.

**Internal:** Uses the built-in microphone.

**External:** Uses the optional PCS-A300 Microphone (s).

**Lip Sync:** Selects whether you use the lip synchronization function.

**On:** Activates the lip synchronization function.

**Off:** Deactivates the lip synchronization function.

**Echo Canceler:** Selects whether you use the echo canceler inside the Compact Processor.

**Internal:** Activates the built-in echo canceler.

**External:** When using the echo canceler equipped with the external equipment.

**Off:** Deactivates the echo canceler.

**Beep Sound:** Selects whether to sound the beep when you press the buttons on the Remote Commander.

**On:** Activates the beep sound.

**Off:** Deactivates the beep sound.

**Recording Mute:** When recording a meeting using a cassette recorder that is connected to both the AUDIO IN jack and the AUDIO OUT (MIXED) jack, you can prevent echos returning to the remote terminals. This function is activated only when Input Select is set to AUX or MIC+AUX.

**On:** Uses the Recording Mute function.

**Off:** Does not use the Recording Mute function.

## General Setup Menu

### Page 1

The screenshot shows a 'General Setup' window with a title bar containing a speaker icon and the text 'General Setup'. Below the title bar is a 'Page: 1/3' indicator with a right-pointing arrow. The main area contains five rows of settings, each with a label and a value field:

- Terminal Name: [Empty text box]
- Dual Monitor: [Off] (dropdown arrow)
- Sleep Mode: [On] (dropdown arrow)
- Sleep Time: [30 minutes] (dropdown arrow)
- Time Display: [On] (dropdown arrow)

At the bottom of the window are two buttons: 'Save' and 'Cancel'. A right-pointing arrow is visible on the right side of the main settings area.

**Terminal Name:** Enter the terminal name to be reported to an external MCU.

(Continued)

**Dual Monitor:** Select whether to use the dual-monitor function.

**On:** Activates the dual-monitor function. Still pictures are displayed on the screen of the second monitor.

**Off:** Deactivates the dual-monitor function.

**Sleep Mode:** Select whether to turn into sleep mode.

**On:** Turns into sleep mode.

**Off:** Does not turns into sleep mode.

**Sleep Time:** Specifies the time to turn into sleep mode. This is set between 1 to 99 minutes.

**Time Display:** Selects whether to display the elapsed time.

**On:** Displays the elapsed time.

**Off:** Does not display the elapsed time.

## Page 2

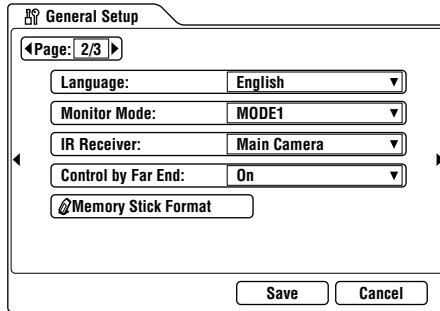

**Language:** Selects the language of the messages.

**English:** Displays in English.

**French:** Displays in French.

**German:** Displays in German.

**Japanese:** Displays in Japanese.

**Spanish:** Displays in Spanish.

**Italian:** Displays in Italian.

**Chinese:** Displays in Chinese.

**Monitor Mode:** Selects the remote control mode of the IR repeater. Normally, set it to MODE1 (PCS-1600) or to MODE3 (PCS-1600P).

**MODE1:** Sets it to mode 1.

**MODE2:** Sets it to mode 2.

**MODE3:** Sets it to mode 3.

**MODE4:** Sets it to mode 4.

**IR Receiver:** Selects the remote sensor. Normally, set it to Main Camera.

**Main Camera:** Activates the remote sensor on the camera.

**Body:** Activates the remote sensor on the Compact Processor.

**Control by Far End:** Selects whether to ignore the camera control commands from the far end.

**On:** Does not ignore the camera control commands.

**Off:** Ignores the camera control commands.

**Memory Stick Format:** Formats the “Memory Stick.”

---

## Page 3

General Setup

Page: 3/3

T.120 PC Address: . . . .

Last Number Registration: On

Save Cancel

**T.120 PC Address:** Input the IP address of the PC used for the T.120 data conference.

**Last Number Registration:** Selects whether or not to register remote parties in the Phone Book after the conference has ended.

**ON:** Register the remote parties in the Phone Book.

**OFF:** Do not register the remote parties in the Phone Book.



## Administrator Setup Menu

This menu is only for an administrator. If you set your password, the password is necessary to modify the Setup and Phone Book menus. Also, the password is necessary to access the Administrator Setup Menu.

Administrator Setup

Page: 1/1

Administrator Password:

Superuser Password:

Remote Access Password:

Web Monitor: On ▼

Save Phone Book

Load Phone Book

Save Cancel

**Administrator Password:** Sets the password for the administrator. This password is necessary to modify the Setup and Phone Book menus. The password is available until the unit turns to standby or the unit is turned off.

**Superuser Password:** Sets the password for the superuser. This password is necessary to modify the Phone Book menu.

**Remote Access Password:** Sets the password to access from the Web. The password for administrator or superuser can also be used to access from the Web.

**Web Monitor:** Selects whether or not the Web monitoring function is used from the Web.

**On:** Gives permission for viewing the JPEG images from the Web.

**Off:** Does not give permission for viewing the JPEG images from the Web.

**Save Phone Book:** Saves the data in the Phone Book into the “Memory Stick.” The data in the “Memory Stick” is overwritten.

**Load Phone Book:** Loads the data of the Phone Book stored in the “Memory Stick.” The data in the Phone Book is overwritten.

## ISDN Setup Menu

Sets up the ISDN attribute. See page 89 for details.

## LAN Setup Menu

When you hold a meeting on a LAN, upgrade the system using the optional PCS-UC161 Upgrade Kit, and set up the LAN Setup menu.

*For details on the setup below, consult a person having charge of your network.*

Page 1

The screenshot shows a window titled "LAN Setup" with a "Page: 1/3" indicator and a right arrow. The window contains the following fields:

- DHCP Mode:** A dropdown menu currently set to "Off".
- Host Name:** A text input field.
- IP Address:** A text input field with three dots as placeholders.
- Network Mask:** A text input field with three dots as placeholders.
- Gateway Address:** A text input field with three dots as placeholders.
- DNS Address:** A text input field with three dots as placeholders.

At the bottom of the window are "Save" and "Cancel" buttons.

**DHCP Mode:** Sets up the DHCP (Dynamic Host Configuration Protocol).

**Auto:** Automatically gets your IP address and network mask.

Check the IP address in the INFORMATION menu.

**Off:** Sets DHCP to Off. When set to Off, enter your IP address, network mask, gateway address, and DNS address.

**Host Name:** Enter your host name.

**IP Address:** Enter your IP address.

**Network Mask:** Enter your network mask.

**Gateway Address:** Enter your default gateway address.

**DNS Address:** Enter your DNS (Domain Name System) server address.

(Continued)

The screenshot shows a dialog box titled "LAN Setup" with a page indicator "Page: 2/3". Inside the dialog, there are four input fields: "Gatekeeper Mode" is a dropdown menu currently set to "Off"; "Gatekeeper Address" is a text box containing three dots; "User Alias" is an empty text box; and "User Number" is an empty text box. At the bottom of the dialog are two buttons: "Save" and "Cancel".

**Gatekeeper Mode:** Sets up whether you use the gatekeeper or not.

**On:** Uses the gatekeeper.

**Off:** Does not use the gatekeeper.

**Auto:** Automatically detects the gatekeeper and use it.

**Gatekeeper Address:** Enter your gatekeeper address.

**User Alias:** Enter your user alias address (H.323 alias) on the gatekeeper.

**User Number:** Enter your user number (E.164 number) on the gatekeeper.

### Note

The LAN Setup menu (Page 2) is accessed only when the system has been upgraded using the optional PCS-UC161 Upgrade Kit.

### Tip

When Gatekeeper Mode is set to On, you can call using your user name or user number alternative to the IP address.

LAN Setup

Page: 3/3

SNMP Mode: On

Trap Destination: . . . .

Community:

Description:

Location:

Contact:

Save Cancel

**SNMP Mode:** Sets up whether the SNMP agent service is effective or not.

**On:** Sets the SNMP agent service effective.

**Off:** Sets the SNMP agent service ineffective.

**Trap Destination:** Enter your SNMP administrator address where you send the trap.

**Community:** Enter your community name that managed by the SNMP administrator. “public” has been entered as the default. Normally, you do not need to change this item.

**Description:** Enter the description of the unit. “Videoconference Device” has been entered as the default. You cannot change this item.

**Location:** Enter the location you install this unit.

**Contact:** Enter information on your administrator who manages this unit.

## Machine Information Menu

Displays the version and installed option of the Compact Processor. To open this menu, select Information from the Setup menu.

The screenshot shows a window titled "Machine Information" with a list of system parameters and their values:

Host Version:	Ver3.10
BRI Version:	Ver3.31
VCP Version:	Ver1.30 Ver2.10
DSP Version:	Ver1.30
Software Option:	None
Option Board:	None
Host Name:	PCS-1600
IP Address:	1.2.3.4
Mac Address:	00-00-00-00-00-00
Serial Number:	12345

An "End" button is located at the bottom right of the window.

**Host Version:** Displays the software version.

**BRI Version:** Displays the BRI version.

**VCP Version:** Displays the VCP version.

**DSP Version:** Displays the audio DSP version.

**Software Option:** Displays the optional software installed into the unit.

**None:** The optional software has not been installed.

**Multipoint:** The PCS-UC160 Upgrade Kit has been installed.

**H.323:** The PCS-UC161 Upgrade Kit has been installed.

**Multipoint&H.323:** The PCS-UC160/UC161 Upgrade Kits have been installed.

**Option Board:** Displays the optional board installed into the unit.

**None:** The optional board has not been installed.

**2BRI:** The PCS-I160 BRI Board has been installed.

**V.35:** The PCS-I161 V.35 Board has been installed.

**Host Name:** Displays the host name.

**IP Address:** Displays the IP address.

**MAC Address:** Displays the MAC address.

**Serial Number:** Displays the serial number.

# ***Meetings With Optional Equipment***

## **Installing the Optional Board**

You need to install the optional board to connect via three ISDN lines or via the V.35 interface.

*For details on the installation of optional Boards, consult your Sony dealer.*

<b>Board</b>	<b>Function</b>
PCS-I160 BRI Board	Connects via three ISDN lines. When using this unit that has been upgraded with the PCS-UC160 as the MCU (Multipoint Control Unit), this board is required.
PCS-I161 V.35 Board	Connects via the V.35 interface.

# Installing the Optional Board

## Using Three ISDN Lines

You need to install the optional PCS-I160 BRI Board. You can connect with 6B channels.

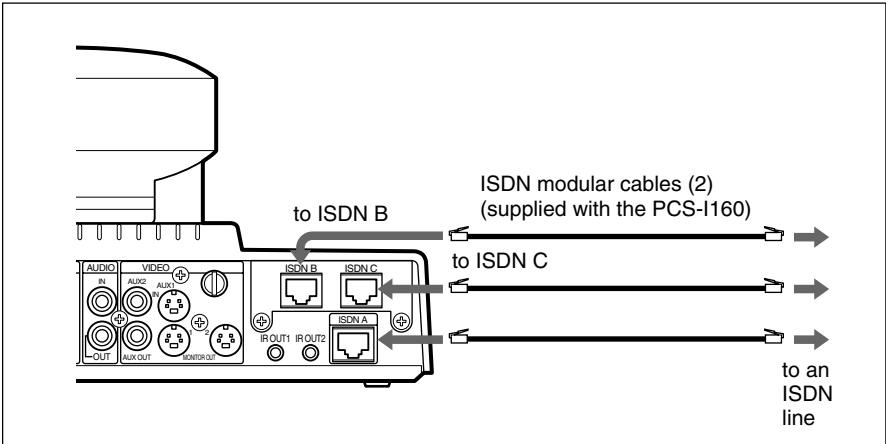

## Using the V.35 Interface

You need to install the optional PCS-I161 V.35 Board. You can connect via the V.35 interface.

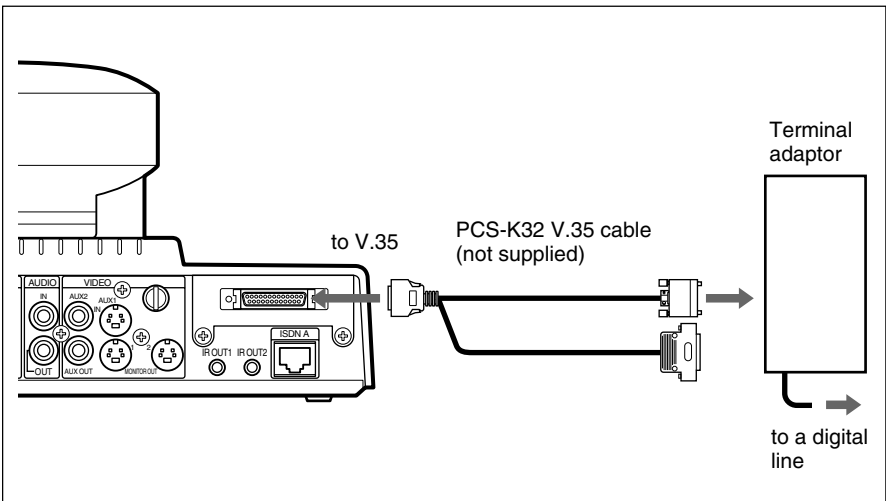

Chapter 5

# Upgrading the Software

Follow the procedure below to upgrade the software (PCS-UC160/UC161).

- 1** Insert the “Memory Stick” into the Memory Stick slot.

Insert it in the arrow mark direction with the mark faced upward.

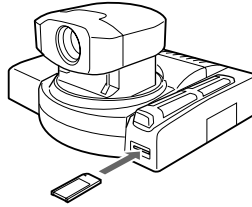

- 2** Turn on the Compact Processor.

After the upgrade is complete, the launcher menu appears.

**Note**

Do not turn off the power or eject the “Memory Stick” before the launcher menu appears.

- 3** Push the “Memory Stick” inward, then release your finger.

The “Memory Stick” comes out a little.

- 4** Open the Machine Information menu to check upgrading is complete.

*For details on the Machine Information menu, see “Machine Information Menu” on page 116.*

- 5** Stick the serial number sticker to the bottom of the Compact Processor.

# Connection using a LAN

You need to upgrade the system using the optional PCS-UC161 Upgrade Kit. You can connect on a LAN. Use the UTP (Unshielded Twisted Pair) category 5 cable.

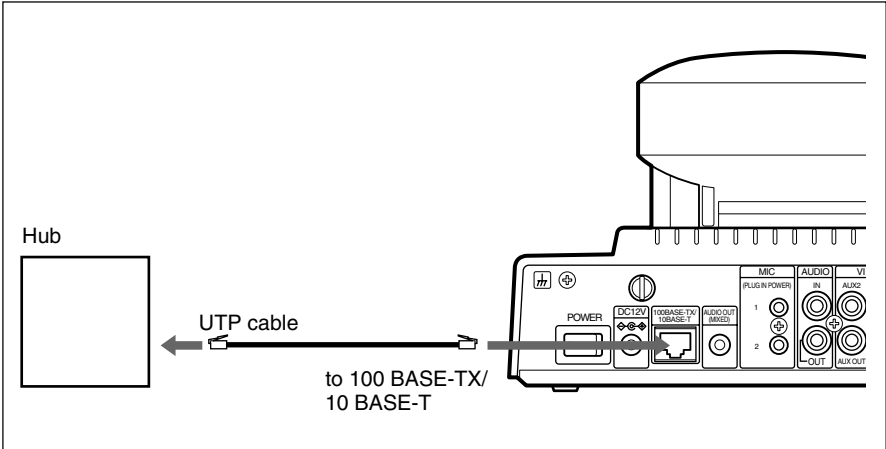

## Note

The mode (communication speed and half-/full-duplex) of the PCS-1600/1600P is set to the automatic mode. If you don't set the hub to automatic or half-duplex, operation may be unreliable.

# Using Dual Monitors

You can use two monitors during a meeting, one for moving pictures and the other for still pictures.

## To connect a TV monitor for the dual monitor function

Connect the second TV monitor (for dual monitor function) to the VIDEO MONITOR OUT2 jack on the Compact Processor. The first TV monitor then becomes the monitor for viewing motion pictures. Insert the IR repeater below the remote sensor of the TV monitor.

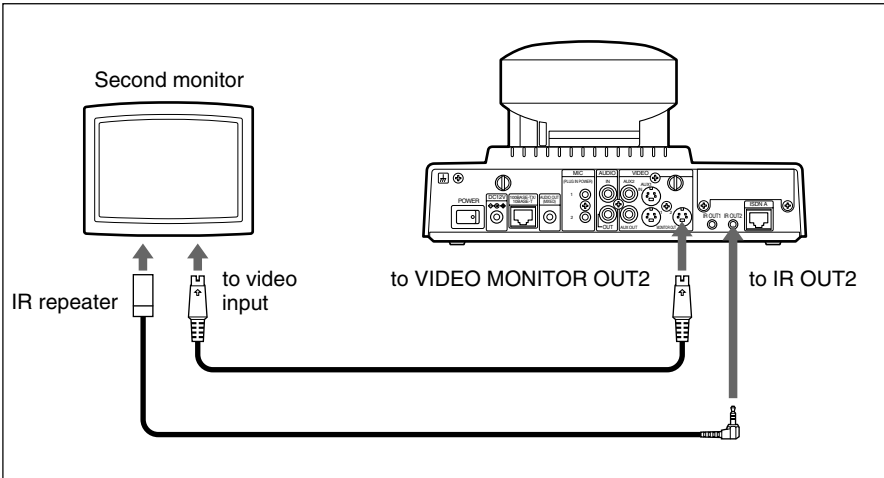

## To enable the dual monitor function

Set Dual Monitor to On in the General Setup menu. The default setting is Off.

*For details on the Dual Monitor item, see “General Setup Menu” on page 109.*

### Note

When Dual Monitor is set to Off, an still image is displayed on the screen of the first monitor.

# Using Optional Microphones

The Compact Conference Package is designed to accommodate three participants at one terminal. You can add the optional PCS-A300 Microphones to allow for more participants.

## Notes

- Set Mic Select to External in the Audio Setup menu.
- The built-in microphone is not activated after connecting the external microphone.

## Connecting the Microphone

You can add two microphones. Power for the microphone is provided from the Compact Processor.

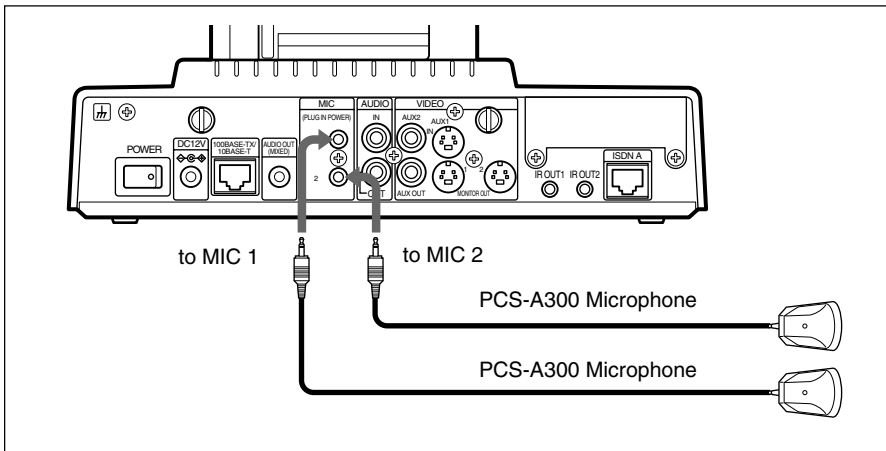

## Notes on installing the PCS-A300 Microphone

- Install the microphone at a half meter apart from participants.
- Install the speaker in direction of the rear of the microphones.
- Install the microphone in a quiet, echo-free room.
- Install the microphone away from potential noise sources.
- Do not place a sheet of paper over the microphone or move the microphone since reflecting echoes to a remote party may increase temporarily. It needs an input audio signal for a couple of seconds to settle down the reflecting echoes.



# Using the External Equipment

The Compact Processor can connect two external video equipment for input; two equipment for output (including the TV monitor).

## Connecting External Video Equipment for Input

Connect video equipment, such as a VCR. The system is equipped with two video inputs and one audio input.

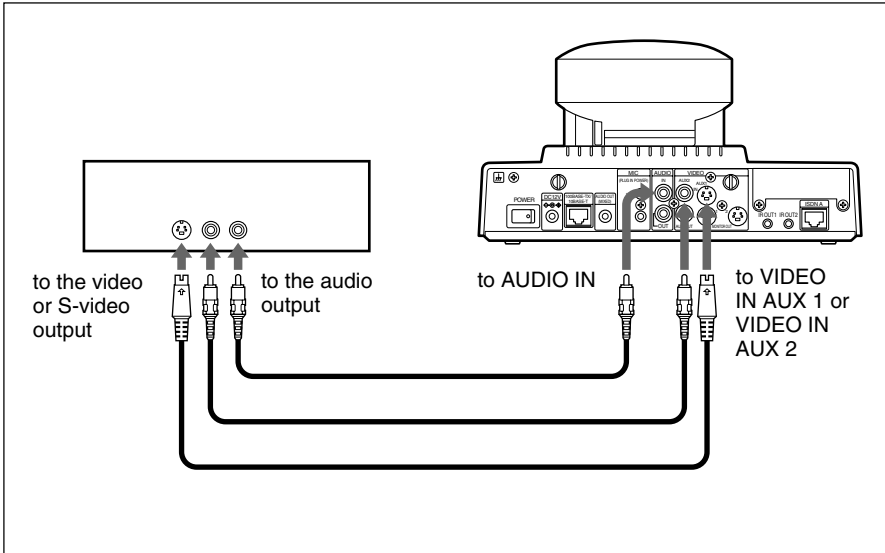

## Connecting External Equipment for Output

You can connect external video equipment for output, such as a VCR, besides the TV monitor.

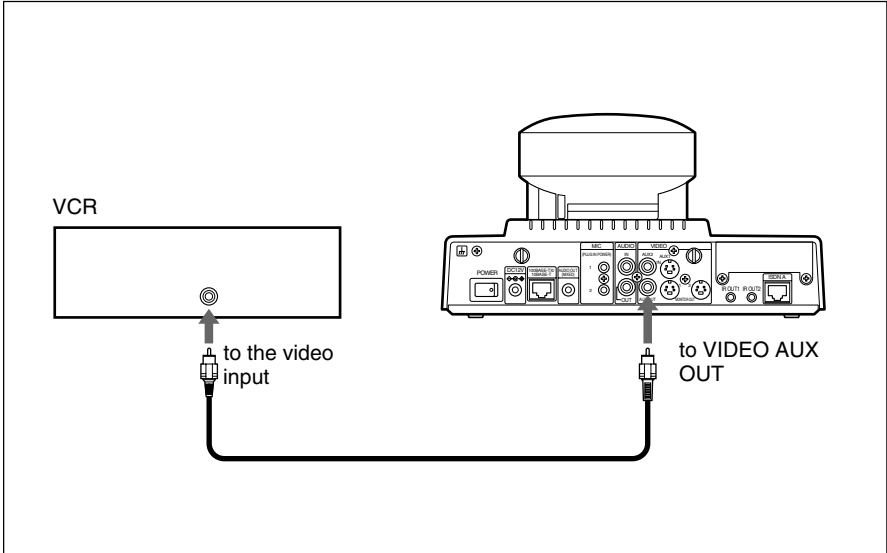

# Holding a T.120 Data Conference

You can have a data conference based on ITU-T Recommendation, T.120 standards when you connect a PC which NetMeeting (not supplied) has been installed with the Compact Processor.

*NetMeeting is a registered trademark of Microsoft Corporation.*

## Notes

- When you have upgraded the system using the optional PCS-UC161 Upgrade Kit, and using on a LAN, you cannot hold a T.120 data conference.
- When you use the Compact Processor as the MCU, you cannot hold a T.120 data conference.

## Connecting With a PC

Connect the LAN port of your PC and the 100BASE-TX/10BASE-T on the Compact Processor using the category 5 UTP cross cable.

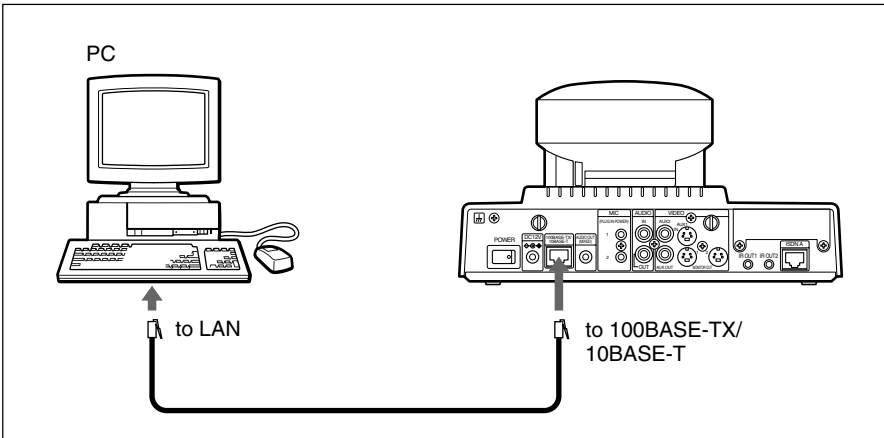

When you use a Hub, connect as follows using straight cables.

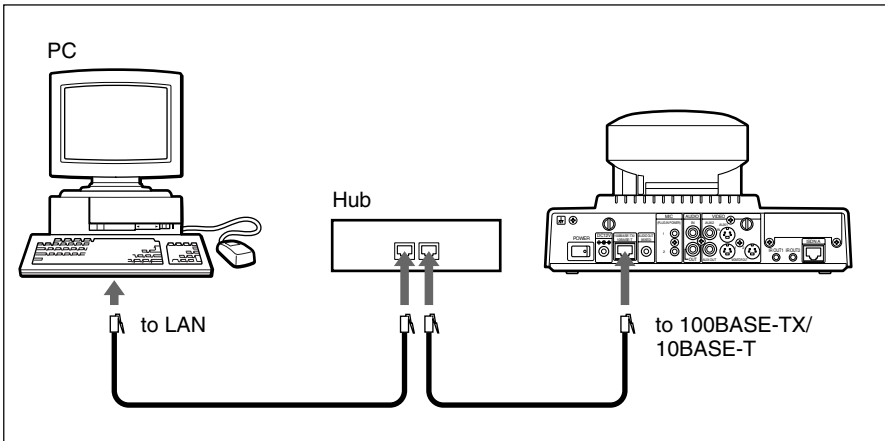

## To install NetMeeting

Install NetMeeting in your PC following the procedure.

## Setting Up the Compact Processor

Enter the IP address of your PC in which NetMeeting is installed into the T.120 PC Address box in the General Setup menu.

**When you call a remote party to hold a data conference**  
Set T.120 Data to On in the Dial Setup menu.

**When you receive a call from a remote party to hold a data conference**  
Set T.120 Data to On in the Answer Setup menu.

### Note

We recommend to set Audio Mode to G.728 in the Dial Setup menu.

## Connecting with NetMeeting

- 1** Select [NetMeeting] from the start pop-up menu or click on the NetMeeting icon.
- 2** Set the Compact Processor to be on line.  
Check that the indication T.120 appears on the screen.
- 3** Click on [Calling] at both local or remote.
- 4** Enter the IP address of the Compact Processor into [Address].
- 5** Click on the [Call] button.

Soon, the connection is established.

*For details on how to use, refer to the NetMeeting Help menu.*

### **On data transfer rate**

The Compact Processor is compatible with the following transfer rate: MLP 6.4 Kbps, 24 Kbps, 32 Kbps, and HMLP 62.4 Kbps.

# Accessing the Unit Using an External Control

The unit can be accepted the following external control. For details, consult your Sony dealer.

## Using a Web Browser

You can access the IP address of the unit from a Web browser to control the unit or set unit preferences.

*For details on the access authority and password, see “Administrator Setup Menu” on page 112.*

## Via the Telnet

You can access the IP address of the unit to control the unit or set unit preferences via the Telnet.

## Via the AUX CONTROL Connector

You can access the IP address of the unit to control the unit or set unit preferences via the AUX CONTROL connector.



# *Meetings With the Multipoint Function*

## Features

The optional PCS-UC160 Upgrade Kit is designed to add the MCU function to the PCS-1600/1600P Compact Conference Package.

You can hold a multipoint conference based on the ITU-T Recommendation, H.231 standard.

### **Note**

The PCS-I160 BRI Board is also required for holding a point to multi-point meeting. (However, you can only install the MCU function without the PCS-I160 BRI Board.)

# Starting a Point to Multi-Point Meeting

You can hold a point to multi-point meeting among four terminals (including this terminal). You can add one normal audio phone in the network.

## Notes

- Before you start a meeting verify that Multipoint Mode is set to On in the Multipoint Setup menu.
- When you establish a connection with a party marked with a Multipoint mark, or with parties on the Multipoint list, the status of the internal Multipoint setting is ignored, and the connection is made using the internal Multipoint mode.

## Registering a Multipoint Conference in the Multipoint connection list

### Setting up a new Multipoint connection list

- 1 Press the Phone Book button on the Remote Commander.

The Phone Book menu appears.

- 2 Select New Entry with the joystick on the Remote Commander, then press the joystick down.

The List Edit menu appears.

The screenshot shows a 'List Edit' dialog box. At the top, there is a tab labeled 'List Edit' and a button with a left arrow, 'ISDN', and a right arrow. Below this is an 'Index:' text box. To the right of the text boxes are several dropdown menus: 'Line I/F:' with 'ISDN' selected, 'Number of Lines:' with '6B' selected, 'Prefix:' with 'Prefix-None' selected, and 'Restrict:' with 'Auto' selected. On the left side, there are five text boxes labeled 'A1:', 'A2:', 'B1:', 'B2:', 'C1:', and 'C2:'. At the bottom of the dialog are two buttons: 'Save' and 'Cancel'.

- 3 Enter the name of the remote party in the Index box.
- 4 Select [ISDN] in Line I/F.

(Continued)

## Starting a Point to Multi-Point Meeting

---

- 5 Select the Line I/F icon or a still image in the “Memory Stick.”

In this case, the Line I/F icon will be .

- 6 Enter the telephone numbers for the remote parties you want to register in items A1 to C2.

A1, A2 are for the telephone number of the first remote party.

B1, B2 are for the telephone number of the second remote party.

C1, C2 are for the telephone number of the third remote party.

(If the Number of Lines item has been set to [1 B], enter the telephone numbers in the text boxes for A1, B1, and C1.)

### Note

When ISDN (Telephone) is selected, you can connect to only one remote location. When you enter the telephone number, enter a “T” before the number.

- 7 Select Prefix.
- 8 Select Save, then press the joystick down.

Registration is complete.

---

### Registering previously registered remote parties in the Multipoint connection list

- 1 Press the PHONE BOOK button on the Remote Commander.

The Phone Book menu appears.

- 2 Select a previously registered remote party using the Phone Book menu, and press the joystick down.

The submenu appears.

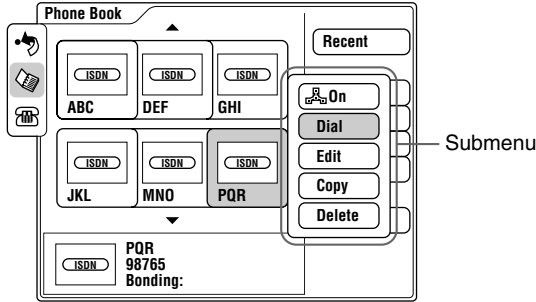

- 3 Select [ On], then press the joystick down.

The mark is displayed in the upper left corner of the remote party list item.

You can attach the mark to up to 3 locations in the same step.

You can confirm how many marks have been attached by checking the menu.

To remove a mark, select a remote party with a mark next to his or her name, select [ Off] from the submenu, then press the joystick down.

**Tip**

You can switch back and forth between ON and OFF using the \* button on the Remote Commander.

Multipoint mark      Multipoint Confirmation mark

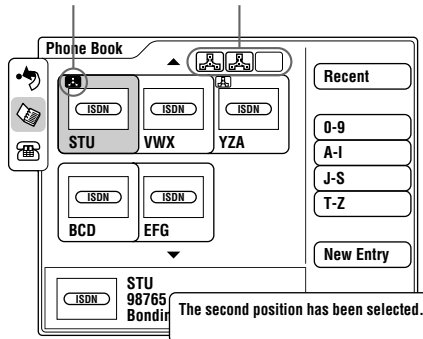



(Continued)

## Starting a Point to Multi-Point Meeting

- 4 Select a remote party with a  mark attached to their name, or select a party you want to add to the Phone Book, then push the joystick down.

The submenu appears.

- 5 Select [Edit], then press the joystick down.

The List Edit menu appears.  
Numbers marked with the  mark of the list are entered in the Telephone number item.

- 6 Enter the remote party's name in the Index box.

- 7 Select a prefix in the Prefix item.

### Notes

- A prefix cannot be copied.
- For the ISDN (Telephone), a “T” is attached to the beginning of the telephone number.

- 8 Select Save, then press the joystick down.

The registration is complete.

## Calling a registered remote party

### Calling a remote party from the Multipoint connection list



- 1 Press the PHONE BOOK button on the Remote Commander.

The Phone Book menu appears.

- 2 Select a remote party from the Multipoint connection list, then press the joystick down.

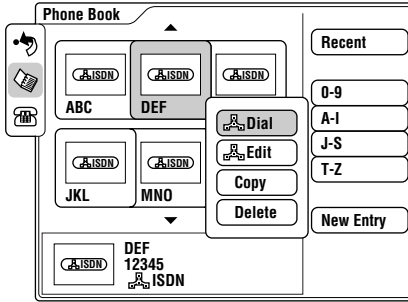
A submenu appears.  
The remote parties in the Multipoint connection list will all have [ISDN] as their Line I/F.



- 3 Select [  Dial ], then press the joystick down. Or press the CONNECT/DISCONNECT button on the Remote Commander.
- 4 The telephone number of the remote party selected in step 2 is dialed, and “  Dialing (ISDN)” is displayed on the monitor screen. When the connection is established with the far end, “You can start the conference..” is displayed.

---

### Calling a previously registered remote party

- 1 Press the PHONE BOOK button on the Remote Commander.



The Phone Book menu appears.

- 2 Select a previously registered remote party using the Phone Book menu, then press the joystick down.

A submenu appears.

- 3 Select [  ON ], then press the joystick down.

The  mark is displayed in the upper left corner of the remote party list item.

You can attach a  mark to up to three remote locations entered in steps 2 and 3 above. You can confirm that the  mark has been attached to the remote locations on the menu.

**Tip**

You can switch back and forth between ON and OFF using the \* button on the Remote Commander. (Continued)



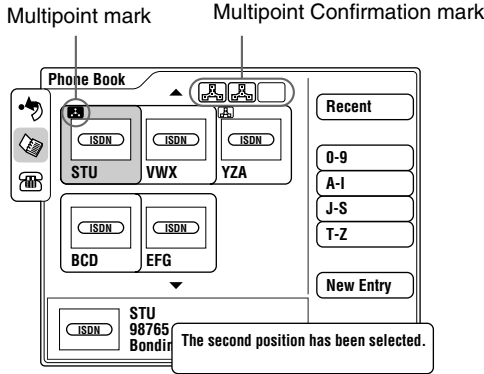

# Starting a Point to Multi-Point Meeting



- 4 Select a remote party that has a  mark and press the joystick down.

A submenu appears.

- 5 Select [ Dial] and press the joystick down. Or press the CONNECT/DISCONNECT button on the Remote Commander.

- 6 The telephone number of the remote party selected in steps 2 and 3 is dialed, and “ Dialing (ISDN)” is displayed on the monitor screen. When the connection is established with the far end, “You can start the conference..” is displayed.

## Note

When connecting to the remote party that is set to be connected via 3B-channel or more, the system only dials the number in the A1 box, or the ones in the A1 and A2 boxes.

---

## When calling remote parties one location at a time

You can connect to remote parties one location at a time in the order they are called when you use [To call from the Phone Book], page 47.

---

## Calling unregistered remote parties

- 1 Select Manual Dial on the Launcher menu with the joystick on the Remote Commander, then press the joystick down.

The Manual Dial menu appears.

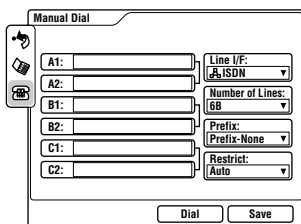

- 2 Select [ISDN] in Line I/F.
- 3 Enter the telephone numbers only for the number of participants in the meeting in A-1 through C-2.  
A1, A2 are for the telephone number of the first remote party.  
B1, B2 are for the telephone number of the second remote party.  
C1, C2 are for the telephone number of the third remote party.  
(If the Number of Lines item has been set to [1 B], enter the telephone numbers in the text boxes for A1, B1, and C1.)

**Note**

When ISDN (Telephone) is selected, you can connect to only one remote location. When you enter the telephone number, enter a “T” before the number.

- 4 Select [Dial] with the joystick on the Remote Commander, then push the joystick down. Or use the Connect/ Disconnect button on the Remote Commander.  
The telephone numbers of the remote parties selected in step 3 are dialed, and “Dialing (ISDN)” is displayed on the monitor screen.  
When the far end connection is made, “You can start the conference..” is displayed on the monitor screen. You can dial one remote location at a time by performing steps 1 to 3 for each one.

**If some locations of the Multipoint connection are not connected**

The following dialog box appears

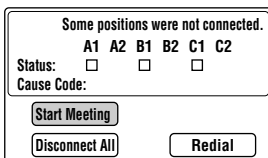

(Continued)

## Starting a Point to Multi-Point Meeting

**Start Meeting:** Starts the conference with the parties currently connected

**Disconnect All:** Disconnects all parties and returns to the Launcher menu.

**Redial:** Redials the numbers for the locations that failed to connect.

---

### To hold a meeting with registered remote parties and unregistered parties mixed

Based on the registration status of the remote parties, you can follow either steps **1** to **5** of [Calling previously registered remote parties], or steps **1** to **4** of [Calling unregistered remote parties], to make your connections.

## Receiving Calls

The procedure is same as a normal meeting.

*For details on the procedure, see “Receiving a Call” on page 49.*

## Notes on Point to Multi-Point Meetings

See also “The Attribute” on page 145.

- The chair control is only available from this terminal. Remote parties cannot operate it.
- This system does not support multiplex MCU connections.
- The number of lines is set to two when Number of Lines is set to 2B; is set to one when set to 1B. This is regardless of the setting in the Dial Setup menu.
- One ISDN jack can connect with only one terminal. Even if you connect via 1B-channel, the number of remote parties is up to three.
- The conference on the video telephone is available in only one location and the 1B connection is established.
- This system does not support connections via the Inverse Multiplexer interface (BONDING).

# Operating Chair Controls

You can do the following operations during a meeting.

## Switching the Broadcast Mode

There are two broadcast modes:

### 4 Split mode

Displays each party on the four-split screen.

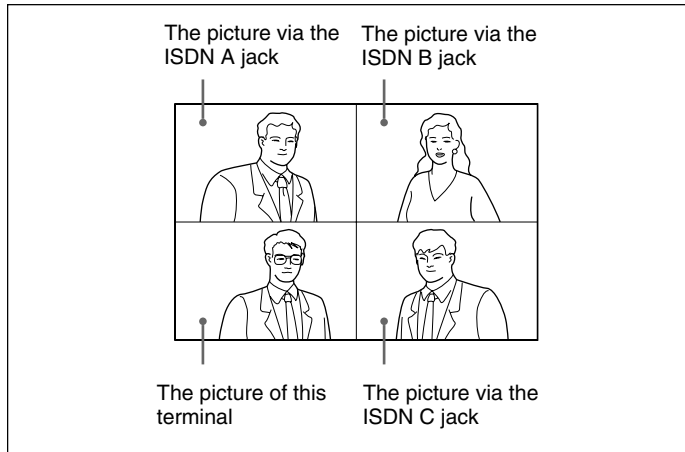

### Voice Activated mode

Detects the terminal that speaks at the highest level among the connected terminals, and sends the picture to all the terminals.

The indication **[V.A]** appears at the lower-left on the monitor screen in Voice Active mode.

The indication **[ ]** appears on the monitor screen when the local picture is broadcast.

The default broadcast mode when starting a meeting is according to the setting in the Multipoint Setup menu.

- 1 Press the FAR/NEAR button on the Remote Commander.

The Display Control menu appears.

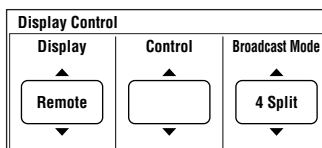

(Continued)

- 2 Select 4 Split or Voice Activated from Broadcast Mode with the joystick on the Remote Commander, then press the joystick.

Each time you select the setting, the mode is switched between the 4 Split mode and the Voice Activated mode.

## Selecting the Picture to be Broadcast

You can manually select the picture to be broadcast. Once you select the picture, both the broadcast modes are canceled, and the selected picture is displayed on each screen at full-size.

Select the desired terminal number from Broadcast Mode with the joystick on the Remote Commander, then press the joystick.

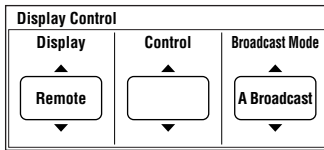

The picture from the selected terminal is broadcast.

The alphabet A, B, or C is added on the indication . This indicates the terminal being broadcast. The indication without the alphabet indicates that the picture of the local terminal is being broadcast.

### To go into broadcast mode

Select 4 Split or Voice Active from Broadcast Mode with the joystick on the Remote Commander, then press the joystick. The system returns to the 4 Split mode or the Voice Activated mode.

---

## Verifying the Picture Shot by the Local Camera

You can only display the local picture on your screen without changing the mode in Voice Activated mode.

Press the FAR/NEAR button on the Remote Commander, then select Local from Display. The local picture is displayed only on your screen.

### To return to the Voice mode

Press the FAR/NEAR button on the Remote Commander again, then select Remote from Display.

## Receiving the Broadcast Request

When you receive the command “MCV”\* from the connected terminal, the picture of that terminal is automatically broadcast. If the meeting is held in Voice mode, the mode is canceled, and the picture is broadcast at full-size.

When you receive the command “MCV CANCEL,” the system returns to the previous mode.

\*One of the commands that is sent to the MCU from the slave terminal.

### Note

If you have received the command “MCV” from other terminal, or you have manually selected the picture to be broadcast, the command “MCV” is rejected.



# Ending a Point to Multi-Point Meeting

- 1 Press the CONNECT/DISCONNECT (🔌/📶) button on the Remote Commander.

The following menu appears on the monitor screen.

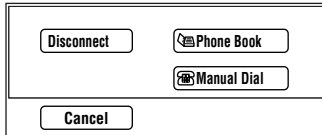

- 2 Select Disconnect with the joystick on the Remote Commander, then press the joystick.

The screen changes to the four-split screen, and the following menu appears on the monitor screen.

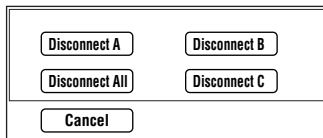

- 3 **To disconnect a selected terminal**

Select the number to be disconnected with the joystick on the Remote Commander, then press the joystick.

The selected terminal is disconnected.

### **To disconnect all the terminals**

Select Disconnect All with the joystick on the Remote Commander, then press the joystick, or press the CONNECT/DISCONNECT (🔌/📶) button on the Remote Commander again.

All of the terminals are disconnected.

### **To cancel the disconnection**

Select Cancel with the joystick in step 3, then press the joystick.

If the terminal that is not adequate for the setting on this system is connected, this terminal is called as the secondary terminal. When the secondary terminal is connected, some of the function is limited as follows:

## **When a normal phone is connected**

You can connect only one normal audio phone in the network. If two phones try to connect, the system will disconnect its line or reject the call.

The audio mode of the other terminals is not influenced:

- Once a phone is connected.
- After the normal phone ends a meeting.

## **When the slave terminals via 1B-channel and 2B-channel are mixed when Number of Lines is set to 2B**

Holds a meeting via 2B-channel with the 2B-channel terminals and via 1B-channel with the 1B-channel terminals. The meeting with the 1B-channel terminals is as follows:

- Send/receive the audio.
- Receive the video.

If 2B-channel terminals end a meeting, and only 1B-channel terminals are in the network, the meeting holds via 1B-channel. This 1B-channel meeting can send/receive the audio and video.

## **When holding a meeting in the 64 K network, the 56 K terminal is connected**

The system automatically changes the transfer rate to 56 Kbps. The slave terminal that cannot change the rate becomes the secondary terminal.

The meeting with the secondary terminal is as follows:

- Send/receive the audio.
- Receive the video.

## **When the different audio mode terminal is connected, and the video mode is different**

The system automatically changes the video rate to the lowest one. The slave terminal that cannot change the video rate becomes the secondary terminal.

The meeting with the secondary terminal is as follows:

- Send/receive the audio.
- Receive the video.

### **When the terminal whose video rate is lower is connected**

Broadcasts the picture to all the terminals with the lowest frame rate in the network.

### **When the terminal whose video mode is only QCIF is connected**

Does not broadcast the picture to the QCIF terminal.

### **When Video Mode is set to H.263**

The H.263 mode is only available when all the terminals are in H.263 mode. If there is a terminal in H.261 mode, the meeting will be held in H.261 mode.

# The Attribute

Number	Attribute	Value
1	Maximum number of terminals that can be connected to a single MCU	3 (4 when including this terminal)
2	Maximum number of concurrent (independent) conferences that can be supported in a single MCU	1
3	Maximum number of ports that can be connected to other MCUs	0
4.1	Network interfaces at each port	BRI
4.2	Restricted network capability	Restrict_Required
5	Transfer rates available at each port	2B, 1B
6	Audio Processor	Equipped
6.1	mixed/switched noise/echo suppression on "silent" ports	Mixed No
6.2	audio algorithm at each port	G.711, G.728, G.722
7	Video Processor (moving pictures)	Equipped
7.1	switched/mixed	Voice activate/four-split/user control
7.2	video algorithm at each port	H.261, H.263
8	Data Processor	No
8.1	data broadcast facility, LSD data broadcast facility, HSD	No No
8.2	MLP Processor	No
9	Encryption	Not support
10	Method of choosing Selected Comm Mode - SCM	Set with users: ISDN rate (1B/2B), audio (G.711/G.722/G.728) Auto: Video frame rate (7.5/10/15 fps), video encoding mode (CIF/QCIF) ISDN transfer rate can be selected from 56 Kbps or automatic with users. Video mode (H.261/H.263) can be selected from H.261 or automatic (H.261/H.263) with users.
11	Can deal with secondary terminals	Audio: send/receive Video: receive
12	Call set-up provision(s)	No call/receive reservation
13	Control capabilities	–
13.1	Numbering of terminals Simple chair control using BAS	No No
13.2	MLP facilities [refer to ITU-T T series]	No No

(Continued)

# The Attribute

---

Number	Attribute	Value
13.3	H.224 (simplex data)	No
14	Cascading	No
14.1	Fixed rates ("simple")	No
14.2	Master/Slave	No
15	Terminal identification	No
16	MBE capability Register necessary information such as the telephone number and index number.	No



# Appendix

## Location and Function of Parts and Controls

### Compact Processor

#### Main unit (front)

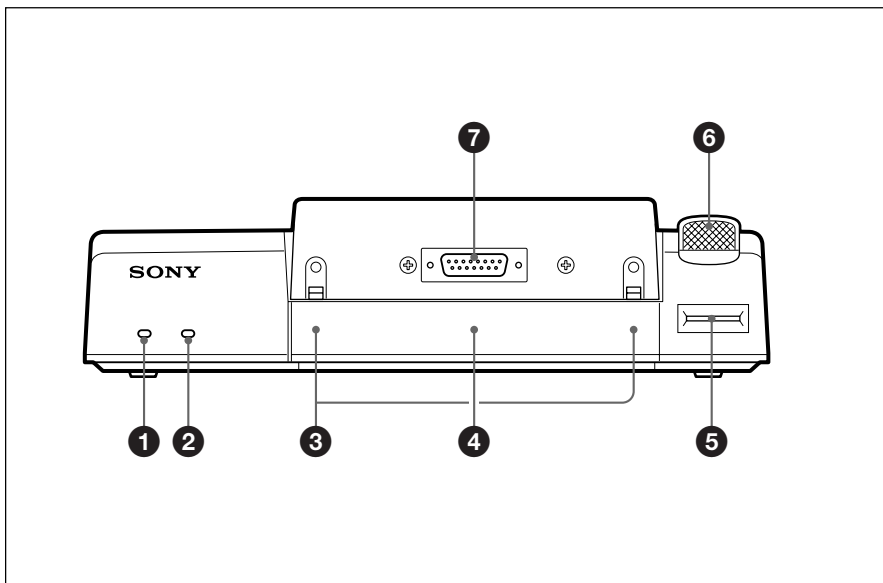

(Continued)

# Location and Function of Parts and Controls

---

## ❶ POWER lamp (green)

When you set the POWER switch to on, this lamp lights up. This lamp goes off when the system is on standby, or flashes when the system is in sleep mode.

## ❷ STANDBY lamp (orange)

This lamp lights up when the system is on standby. This lamp goes off when the system is in sleep mode.

## ❸ IR (Infrared) sensor

Detects the infrared video signal emitted from the optional PCS-DS150/DS150P Document Stand. The infrared video input via this sensor is assigned as Object.

## ❹ Remote sensor

When operating the Compact Processor with the Remote Commander, point it toward this sensor.

If you use this sensor, set IR Receiver to Body in the General Setup menu. This is set to Main Camera at factory.

## ❺ “Memory Stick” slot

Insert a “Memory Stick” into this slot.

## ❻ Microphone

## ❼ CAMERA connector

Connect to the camera.



## Main unit (rear)

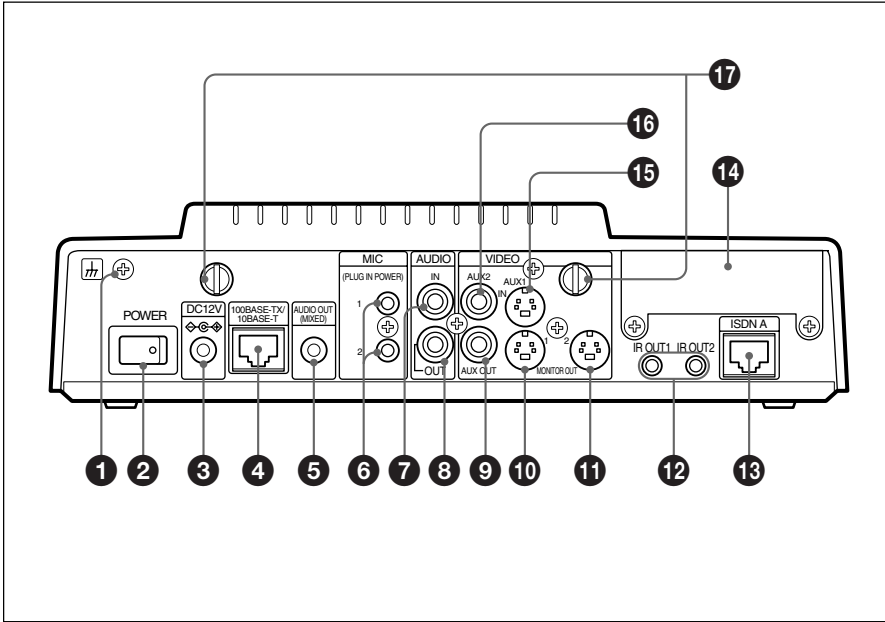

### 1 Terminal

Connect the earthing wire to this terminal.

### 2 POWER switch

Switch the Compact Processor to on/off.

### 3 DC 12V jack

Connect the supplied PCS-AC15 AC adaptor to this jack.

### 4 100BASE-TX/10BASE-T jack (8-pin modular)

Connect another Compact Processor to this jack when holding a meeting on a LAN using a category 5 cable.

### 5 AUDIO OUT (MIXED) jack (phono jack)

Connect to an audio input jack of a VCR to minute a meeting.

### 6 MIC1/MIC2 jacks/PLUG IN POWER (phono jack)

Connect the optional PCS-A300 Microphone(s) to these jacks. These provide the power supply to the microphone(s) connected to these jacks.

### 7 AUDIO IN jack (phono jack)

Connect to the audio output jack of the external equipment.

### 8 AUDIO OUT jack (phono jack)

Connect to the audio input jack of the TV monitor.

(Continued)

# Location and Function of Parts and Controls

---

## 9 VIDEO AUX OUT jack (phono jack)

Connect to the video input jack of the external equipment.

## 10 VIDEO MONITOR OUT1 jack (mini DIN 4-pin)

Connect to the video input jack of the TV monitor.

## 11 VIDEO MONITOR OUT2 jack (mini DIN 4-pin)

Connect to the video input jack of the second TV monitor when using the dual monitor function.

## 12 IR OUT1/2 jacks (minijack)

Connect the supplied IR repeater to these jacks. Connect the IR repeater to the IR OUT1 jack for the monitor connected to the VIDEO MONITOR OUT1 jack and connect the IR repeater to the IR OUT2 jack for the monitor connected to the VIDEO MONITOR OUT2 jack.

## 13 ISDN A jack (8-pin modular)

Connect the ISDN line to this jack using the ISDN modular cable.

## 14 Interface board slot

Install the optional board into this slot.

## 15 VIDEO IN AUX 1 jack (mini DIN 4-pin)

Connect to the video output jack of the external equipment.

## 16 VIDEO IN AUX 2 jack (phono jack)

Connect to the video output jack of the external equipment.

## 17 Camera screws

Loosen these screws to detach the camera from the main unit.

### Note

Tighten the camera screws firmly. If the screws are loose, the camera may fall down, and it causes personal injury.

## Camera

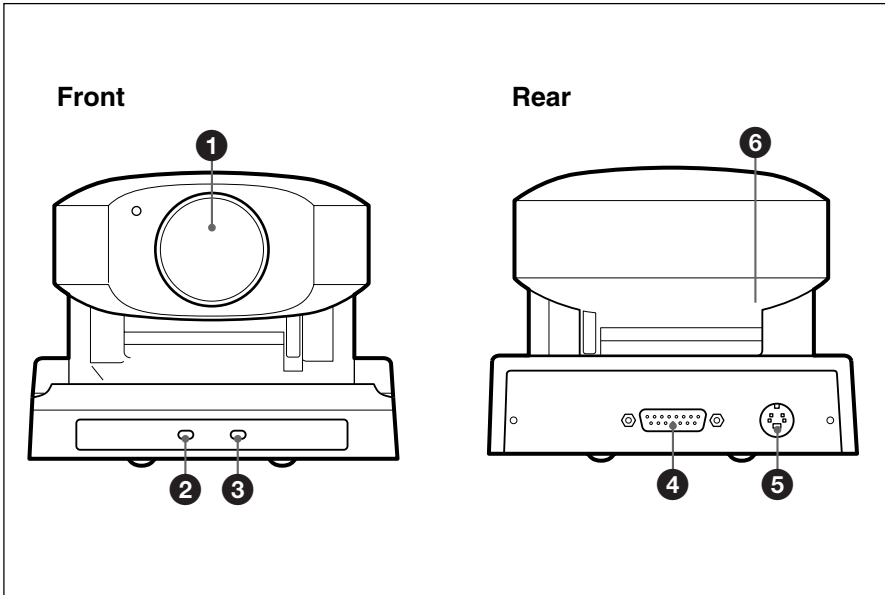

**1 Lens**

**2 POWER lamp (green)**

When you set the POWER switch to on, this lamp lights up. This lamp goes off when the system is on standby.

**3 Remote sensor**

When operating the Compact Processor, point it toward this sensor. Normally, use this sensor for operation.

**4 PROCESSOR connector**

Connect to the main unit.

**5 VISCA OUT connector**

This is deactivated in this system.

**6 BACKUP switch**

Set it to ON to store the presets.

# Location and Function of Parts and Controls

## Remote Commander

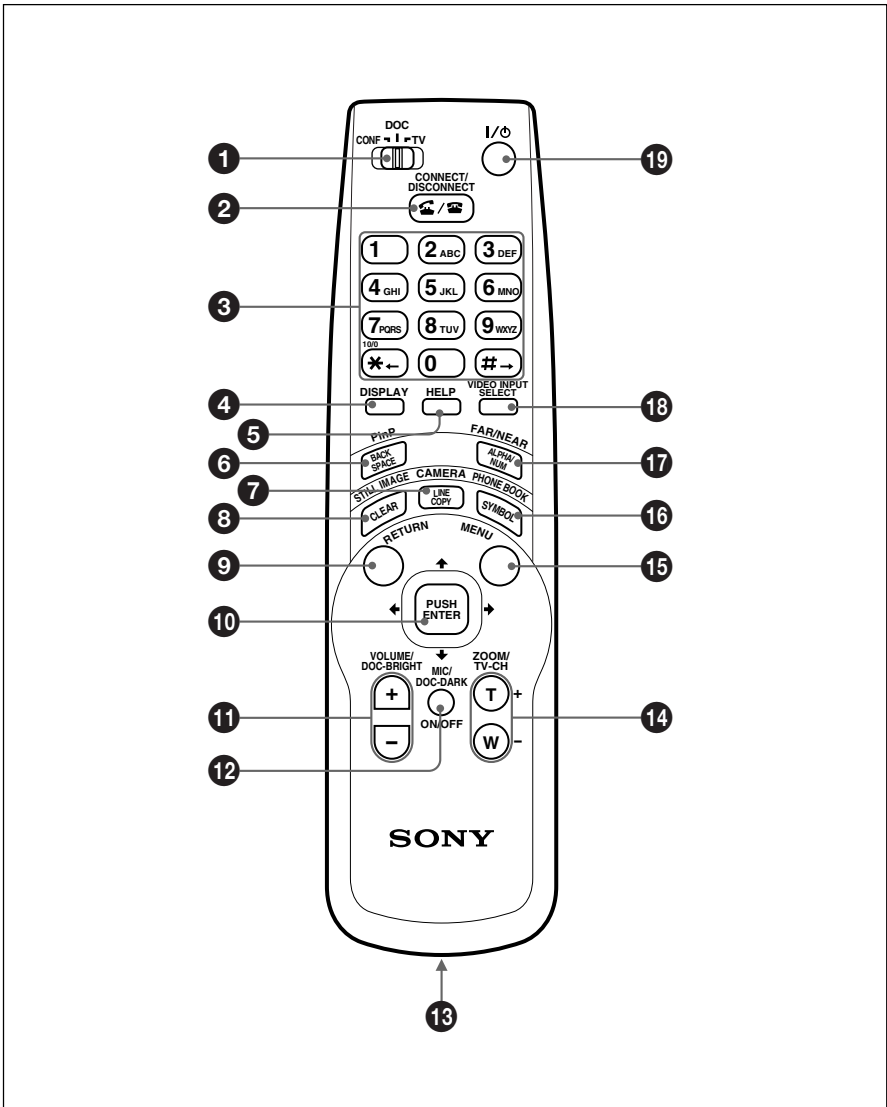

When you press the buttons on the Remote Commander, you can hear the beep from the Compact Processor. If you do not need to hear the beep, you can mute the beep in the menu setting.

*For details, see “Audio Setup Menu” on page 108.*

**Note**

When you operate the Compact Processor, set the CONF/DOC/TV selector to “CONF.”

**1 CONF/DOC/TV selector**

Selects the equipment to operate.

**CONF:** Operates the Compact Processor.

**DOC:** Operates the optional PCS-DS150/DS150P Document Stand.

**TV:** Operates a Sony TV.

**2 CONNECT/DISCONNECT (↔) button**

Press this button to connect or disconnect a remote party.

**3 Number (0 – 9, #, \*) buttons**

Press these buttons to input characters, such as a telephone number, sub-address, or a name.

These buttons can also be used when adjusting the focus, adjusting the brightness of the screen, and compensating for backlighting.

**4 DISPLAY button**

Press this button to display indicators.

**5 HELP button**

Press this button to display an information guide.

**6 PinP (BACK SPACE) button**

Press this button to display the inset window. When inputting characters, use this button to delete the last character.

**7 CAMERA (LINE COPY) button**

Press this button to display the Camera menu. When inputting characters, use this button to copy the characters to the next box.

**8 STILL IMAGE (CLEAR) button**

Press this button to display the Still Image menu. When inputting characters, use this button to delete all the characters in the box.

**9 RETURN button**

Press this button to go back to the previous menu.

**10 Joystick**

Use the joystick to select the menu or an item, or to control the camera.

**11 VOLUME/DOC-BRIGHT (+/-) buttons**

These buttons adjust the volume.

**+**: press to increase the volume.

**-**: press to decrease the volume.

**12 MIC/DOC-DARK (ON/OFF) button**

This button mutes the sounds of the local party. Press again to cancel the muting.

**Note**

The name of the button has the word DARK, however, this does not function in this system.

*(Continued)*

## Location and Function of Parts and Controls

---

### 13 Battery compartment

Insert two size AA (R6) batteries.

### 14 ZOOM/TV-CH (T+/W-) buttons

These buttons control the zoom of the camera.

**T+:** press to zoom in the picture.

**W-:** press to zoom out the picture.

### 15 MENU button

Displays the menu on the monitor screen.

### 16 PHONE BOOK (SYMBOL) button

Press this button to display the Phone Book menu.

### 17 FAR/NEAR (ALPHA/NUM) button

Switches the picture between local and remote.

### 18 VIDEO INPUT SELECT buttons

Selects the input.

### 19 I/⏻ button

Press this button to turn into standby when the system is turned on; to turn on the system when the system is on standby.

---

## To operate a Sony TV monitor

### Note

When you operate a Sony TV, set the CONF/DOC/TV selector to "TV."

### 11 VOLUME/DOC-BRIGHT (+/-) buttons

These buttons adjust the volume.

**+**: press to increase the volume.

**-**: press to decrease the volume.

### 14 ZOOM/TV-CH (T+/W-) buttons

These buttons select the channel of the TV monitor.

**T+:** Tunes to the upper channel.

**W-:** Tunes to the lower channel.

### 18 VIDEO INPUT SELECT button

Selects the input of the TV monitor.

### 19 I/⏻ button

Turns on/off the TV monitor when using an NTSC type TV monitor.

Turns off the TV monitor when using a PAL type TV monitor.

# On Screen Messages

The following messages appear on the TV monitor when using the Compact Processor and give instructions on dealing with them.

Message	Remedy
Incorrect dialing setup.	Make sure the selected entry is correctly registered.
CANNOT COMPLETE CONNECTION (The following code and message appear.)	—
0 Unknown network error:	Try again later.
1 Number does not exist:	Check the number and try again.
2,3,6 Network congestion:	Try again later.
16 Normal disconnection:	(The line has been disconnected normally.)
17 Line is busy:	Try again later.
18,19 System not responding:	Check if the remote system is connected.
21 Call rejected:	Check if the remote system is connected.
22 Called party number changed:	Check the number and try again.
26 Connection restoration request:	Try again later.
27 Remote system out of order:	Check if the remote system is operational.
28 Invalid number entered:	Check the number and try again.
31, 34, 41 – 44, 47 Network not available:	Try again later.
50 Not a Subscriber:	Check the remote party's facility contract.
57,58 Bearer capability not authorized:	Check if the line rate is set correctly.
70 Restricted capability:	Set the line rate to 56K and try again.
88 Terminal attribute error:	Check the connection of the remote system.
91, 95 – 102, 111 Protocol error:	Turn off and restart the system and try again.
128 H.221 negotiation timeout:	Turn off and restart the system and try again.
131 Board mismatch:	Check the optional line interface boards.
132 Invalid SPID:	Reregister the SPID.
134 Physical link synchronization error:	Check the connection of the ISDN cable.
144, 145 Bonding negotiation timeout:	Turn off and restart the system and try again.

(Continued)

# On Screen Messages

Message	Remedy
177 LAN connection timeout:	Try again later.
178 LAN connection rejected:	Try again later.
179 DNS error:	Please check DNS.
180 Dialing your own number is invalid:	Please check the address and try again.
181 GateKeeper error:	Please check the address and try again.
Far end inactive	The remote party operates the menu.
Close this menu to connect line	Close the menu.
Cannot establish all connections	Check to see if your partner's telephone number is the correct one.
Communication error	Wait for a while and then try dialing again.
Configuration error	Wait for a while and then try dialing again.
Command is rejected by MCU	The function does not support MCU if the same operation displays this message again.
Corruptive data stream. Terminate the connection	A signal error occurred. The line connections are compelled to be disconnected.
Memory full	The memory capacity of the "Memory Stick" is full.
Input title	Input an index title.
Operation disabled	—
Wrong password	The password is wrong.
LAN configuration error (IP address)	The IP address is not proper.
LAN configuration error (Netmask)	The netmask is not proper.
LAN configuration error (MAC address)	The MAC address is not proper.
LAN configuration error (DHCP error)	The IP address and netmask cannot be got.
Gatekeeper registration error	The setting of the Gatekeeper is not proper.
LAN configuration error (Gatekeeper)	The setting of the Gatekeeper is not proper.
LAN configuration error (SNMP error)	The setting of the SNMP is not proper.
LAN configuration error	The setup in the LAN Setup menu is not proper.
Memory Stick error.	The format of the "Memory Stick" is wrong.

---

The following messages indicate the state of the system. No action is required.

<b>Message</b>	<b>Meaning</b>
Meeting starts!	Connection with the remote party has been completed, the meeting can now begin.
Meeting ends	Operations for ending the meeting have been completed.
Site A (B/C) has disconnected	The remote party A (B/C) has been disconnected.
Installation completed	The installation of the Upgrade Kit is completed.
Transmission of the still picture is completed.	The transmission of the still picture is completed.
Still image transmission cancelled	The transmission of the still image was canceled.
Still image saved	The still picture was saved to the "Memory Stick."
Registered to X (1-6)	The setting of the zoom and angle was registered to X (1-6).



# Troubleshooting

If the Compact Processor does not function or functions incorrectly, check the following.

Symptom	Cause	Solution
The power is not turned on.	The POWER switch is not set to on.	Set the POWER switch to on. See page 21.
	The batteries in the Remote Commander are low or dead.	Replace the batteries with new ones. See page 17.
	The CONF/DOC/TV selector is not set to "CONF."	Set the CONF/DOC/TV selector to "CONF."
No sound or the volume is very low.	The volume is too low.	Adjust the sound volume by pressing the VOLUME/DOC-BRIGHT buttons on the Remote Commander. See page 54.
	The remote party has muted their sound.	Wait until the sound transmission from the remote party resumes.
	The Mic Select is not set properly.	Set up Mic Select properly according to the microphone to be used. See page 108.
	Audio input is not selected properly.	Set up Input Select properly. See page 108.
Picture is blurred.	Manual focus is selected but picture remains blurred.	Adjust the focus. See page 58.
	When auto focus is selected, the background is too bright, contrast is too high, or the background or the participants' clothes contain fine line patterns.	Select manual focus and adjust manually. See page 58.
No picture.	The selected picture source is not tuned on.	Turn on the selected video equipment.
	Video input is not selected properly.	Select the video input with the VIDEO INPUT SELECT button. See page 64.
	The selected picture source is not correctly connected to the system.	Check the connection. See page 124.
	The unit has not been connected properly to a digital line.	If you have installed an optional V.35 Board, make sure the system is connected to an ISDN outlet or a digital line outlet with the terminal adaptor. See pages 16 and 118.
	A voice meeting is held.	This is not a malfunction.

Symptom	Cause	Solution
Does not connect with a remote party.	The terminal adaptor is not turned on (if you have installed an optional interface board).	Turn on the terminal adaptor.
	The remote party has not been registered in the system yet.	Register the remote party. See page 81.
Still pictures or the Phone Book cannot be saved to the "Memory Stick."	The write-protect tab on the "Memory Stick" is set to LOCK.	Set the tab to write.
	The "Memory Stick" has already been recorded to its full capacity.	Use other "Memory Stick."



# Specifications

## Compact Processor

This unit is compliant with ITU-T Recommendations H.320 and H.323.

### Motion video

Operating bandwidth	56 Kbps to 128 Kbps (standard) 56 Kbps to 384 Kbps (when installing the PCS-I160) 64 Kbps to 1024 Kbps (when upgrading with the PCS-UC161 and connecting on a LAN)
Coding	H.261 (ITU-T Recommendation) H.263 (ITU-T Recommendation)
Picture elements	CIF: 352 pixels × 288 lines QCIF: 176 pixels × 144 lines
Color system	NTSC (PCS-1600) PAL (PCS-1600P)

### Still Picture

Pixels	704 pixels × 480 lines (PCS-1600) 704 pixels × 576 lines (PCS-1600P)
Encoding	H.261 Annex D (4CIF)

### Sound

Bandwidth	7 kHz (G.722, ITU-T Recommendation) 3.4 kHz (G.711/G.723.1/G.728, ITU-T Recommendation)
-----------	--

### Transfer rate

48 Kbps to 64 Kbps (G.722, ITU-T Recommendation)
56 Kbps to 64 Kbps (G.711, ITU-T Recommendation)
16 Kbps (G.728, ITU-T Recommendation)
6.4 Kbps (G.723.1, ITU-T Recommendation) (when upgrading with the PCS-UC161 and connecting on a LAN)

### Network

Multiplexing	Video, audio, data
Frame format	H.221 (ITU-T Recommendation)
Interface	ISDN (BRI) up to 1 line (or up to 3 lines when installing the PCS-I160) V.35 (RS-366) (when installing the PCS-I161): 56 Kbps, 64 Kbps, 56 Kbps to 384 Kbps LAN (when upgrading with the PCS-UC161 and connecting on a LAN): 64 Kbps to 1024 Kbps
Data transfer rate	LSD 1.2 Kbps, 4.8 Kbps, 6.4 Kbps MLP 6.4 Kbps, 24 Kbps, 32 Kbps HMLP 62.4 Kbps, 64 Kbps

LAN protocol supported

HTTP  
FTP  
Telnet  
RTP/RTCP  
TCP/UDP

---

## Microphone

Bandwidth 7.0 kHz

---

## Remote control

Far end camera control

H.281 (ITU-T  
Recommendation)

Data transfer

T.120 (ITU-T  
Recommendation)

---

## Camera

Video signal

NTSC color, EIA  
standards (PCS-1600)  
PAL colour, CCIR  
standards (PCS-1600P)

Image device

1/3-inch CCD (Charge  
Coupled Device)  
Approx. 410 000 pixels  
(Effective: approx.  
380 000 pixels) (PCS-  
1600)  
Approx. 470 000 pixels  
(Effective: approx.  
440 000 pixels) (PCS-  
1600P)

Lens  $f = 5.4$  to  $64.8$  mm, F 1.8  
to 2.7, Horizontal angle  
 $4.3^\circ$  to  $48.8^\circ$

Focal distance

10 to 800 mm

Minimum illumination

7 lux at F 1.8/50 IRE

Illumination range

7 lux to 100 000 lux

Horizontal resolution

460 TV lines (PCS-1600)

450 TV lines (PCS-  
1600P)

Pan/tilt action

Horizontal  $\pm 100^\circ$

Vertical  $\pm 25^\circ$

---

## General

Power consumption

12V, 2.5 A

Operating temperature

$5^\circ\text{C}$  to  $35^\circ\text{C}$  ( $41^\circ\text{F}$  to  
 $94^\circ\text{F}$ )

Operating humidity

20% to 80%

Storage temperature

$-20^\circ\text{C}$  to  $+60^\circ\text{C}$  ( $-4^\circ\text{F}$  to  
 $+140^\circ\text{F}$ )

Storage humidity

20% to 80% (no  
condensation)

Dimensions  $258 \times 134 \times 216$  mm (w/  
h/d) ( $10 \frac{1}{4} \times 5 \frac{3}{8} \times$   
 $8 \frac{5}{8}$  inches) excluding  
protruding parts

Mass

Approx. 2.7 kg (5 lb 15 oz)

Supplied accessories

Remote Commander (1)  
Size AA (R6) batteries  
for Remote  
Commander (2)  
IR repeater (2)  
MSA-16A "Memory  
Stick" (1)

S-video connecting cord  
(1.5 m, 4.9 ft) (1)

Audio connecting cable  
(1 m, 3.3 ft) (1)

ISDN modular cable  
(5 m, 16.4 ft) (1)

# Specifications

AC adaptor (1)  
Power cord (1)  
21-pin adaptor (1) (PCS-1600P only)  
Velcro (2)  
CD-ROM (1)  
Operating guide (1)

## Remote Commander (PCS-R160)

### Signal format

Infrared SIRCS

Control DC 3V using two size AA (R6) batteries

Dimensions 50 × 23.4 × 190 mm (w/h/d) (2 × <sup>15</sup>/<sub>16</sub> × 7 <sup>1</sup>/<sub>2</sub> inches)

Mass Approx. 150 g (5 oz) (including batteries)

## AC Adaptor (PCS-AC15)

### Power requirements

100 to 240V AC,  
50/60 Hz

### Power consumption

Approx. 1.0 A to 0.6 A

### Operating temperature

5°C to 35°C (41°F to 94°F)

### Operating humidity

20% to 80%

### Storage temperature

-20°C to +60°C (-4°F to +140°F)

### Storage humidity

20% to 80% (no condensation)

Dimensions 93 × 34 × 165 mm (w/h/d) (3 <sup>3</sup>/<sub>4</sub> × 1 <sup>3</sup>/<sub>8</sub> × 6 <sup>1</sup>/<sub>2</sub> inches)

Mass Approx. 470 g (1 lb 1 oz)

## Optional microphone PCS-A300

Bandwidth 7.0 kHz

Dimensions 68 × 15 × 90 mm (w/h/d) (2 <sup>3</sup>/<sub>4</sub> × <sup>19</sup>/<sub>32</sub> × 3 <sup>5</sup>/<sub>8</sub> inches)

Mass Approx. 200 g (7 lb 1 oz)

Power Plug in power

## Upgrade Kit PCS-UC160/UC161

Dimensions 50 × 2.8 × 21.5 mm (w/h/d) (2 × <sup>1</sup>/<sub>8</sub> × <sup>7</sup>/<sub>8</sub> inches)

Mass Approx. 4 g (0.14 oz)

### Supplied accessories

Serial number sticker (1)

Operating instructions (1)

Design and specifications are subject to change without notice.

## Pin Assignment

### 100BASE-TX/10BASE-T jack



#### Modular jack

Pin	Signal	Description
1	TPOP	Transmit+
2	TPON	Transmit-
3	TPIN	Receive+
4	NC	—
5	NC	—
6	TPIN	Receive-
7	NC	—
8	NC	—

### ISDN A jack



#### Modular jack

Pin	Signal	Description
1	NC	
2	NC	
3	TA	Transmit+
4	RA	Receive+
5	RB	Receive-
6	TB	Transmit-
7	NC	
8	NC	

### AUX1 IN/MONITOR OUT jacks



#### Mini-DIN 4-pin jack

Pin	Signal	Description
1	AGND	Analog Ground
2	AGND	Analog Ground
3	Y	Brightness Signal
4	C	Chrominance Signal

### CAMERA connector (female)

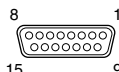

#### D-sub 15-pin connector

Pin	Signal	Description
1	Y	Brightness signal
2	Y.GND	Brightness signal ground
3	C	Chrominance signal
4	C.GND	Chrominance signal ground
5	GND	Ground
6	GND	Ground
7	TxD	Transmit data
8	RxD	Receive data
9	12V	12V
10	12V	12V
11	GND	Ground

(Continued)

# Specifications

12	SIRCS	Remote control data
13	DTR	Data terminal ready
14	Lock	Lock
15	GND	Ground

## PROCESSOR connector (male)

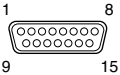

## D-sub 15-pin connector

Pin	Signal	Description
1	Y	Brightness signal
2	Y.GND	Brightness signal ground
3	C	Chrominance signal
4	C.GND	Chrominance signal ground
5	GND	Ground
6	GND	Ground
7	RxD	Receive data
8	TxD	Transmit data
9	12V	12V
10	12V	12V
11	GND	Ground
12	SIRCS	Remote control data
13	DTR	Data terminal ready
14	GND	Ground
15	GND	Ground

## AUX CONTROL connector (male)



## D-sub 9-pin connector

Pin	Signal	Description
1	DCD	Carrier detect
2	RXD	Receive Data
3	TXD	Transmit Data
4	DTR	Data Terminal Ready
5	GND	Ground
6	DSR	Data Set Ready
7	RTS	Request to Send
8	CTS	Send Ready
9	RI	Call

## Pin Assignment on Optional Board Connectors

## ISDN B/C jacks (PCS-I160)



## Modular jack

Pin	Signal	Description
1	NC	
2	NC	
3	TA	Transmit+
4	RA	Receive+
5	RB	Receive-
6	TB	Transmit-
7	NC	
8	NC	

## V.35 connector (female) (PCS-I161)

PCS-K32 V.35 adapter connector cable

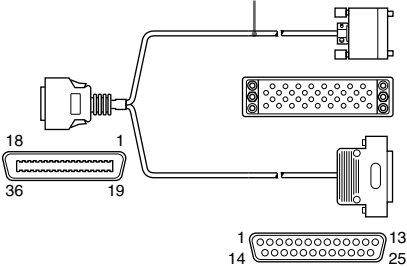

### Half-pitch 36-pin connector

Pin	Signal	Description
1	SGND	Signal ground
2	SGND	Signal ground
3	CABLE1	Cable1
4	V35SD+	Send data+
5	V35SD-	Send data-
6	V35RD+	Receive data+
7	V35RD-	Receive data-
8	V35ER	Data terminal ready
9	V35RS	Request to send
10	V35ST+	Transmit Timing+
11	V35ST-	Transmit Timing-
12	V35RT+	Receive Timing+
13	V35RT-	Receive Timing-
14	V35TT+	Send Timing+
15	V35TT-	Send Timing-
16	SGND	Signal ground
17	SGND	Signal ground
18	SGND	Signal ground
19	SGND	Signal ground
20	SGND	Signal ground

21	CABLE2	Cable2
22	V35RI	Call Indication
23	V35DR	Data set ready
24	366DLO	Data line occupied
25	V35CS	Ready to send
26	366ACR	Abandon call
27	366DPR	Number display
28	366CRQ	Call request
29	366PND	Next no. request
30	366NB1	Numerical signal #1 bit
31	366NB2	Numerical signal #2 bit
32	366NB4	Numerical signal #4 bit
33	366NB8	Numerical signal #8 bit
34	SGND	Signal ground
35	SGND	Signal ground
36	SGND	Signal ground

# Specifications

CCITT V.35 connector (cable side)

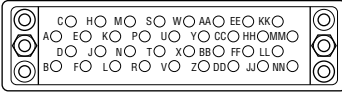

Pin	Signal	Description
A	CGND	Chassis ground
B	SGND	Signal ground
C	V35RS	Request to send
D	V35CS	Clear to send
E	V35DR	Data ready
H	V35ER	Data terminal ready
J	V35RI	Call display
P	V35SD+	Send data+
R	V35RD+	Receive data+
S	V35SD-	Send data-
T	V35RD-	Receive data-
U	V35TT+	Transmit timing+
V	V35RT+	Receive timing+
W	V35TT-	Transmit timing-
X	V35RT-	Receive timing-
Y	V35ST+	Send timing+
AA	V35ST-	Send timing-

D-sub 25-pin connector (cable side)

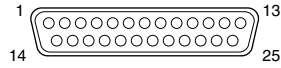



Pin	Signal	Description
1	SGND	Signal ground
2	366DPR	Number display
3	366ACR	Abandon call
4	366CRQ	Call request
5	366PND	Present next digit
7	SGND	Signal ground
14	366NB1	Numerical signal 0 bit
15	366NB2	Numerical signal 1 bit
16	366NB4	Numerical signal 2 bit
17	366NB8	Numerical signal 3 bit
18	366RC	Receive common
19	SGND	Signal ground
22	366DLO	Data line occupied

# Videomeeting Room Layout

Be sure to position camera and microphone appropriately in your videomeeting room.

## Camera Range

 represents the scope of the camera when the zoom has been extended fully.  indicates the scope of the camera when the left/right angling function is fully utilized. Use the measurements below as a guide for the layout of your videomeeting room.

### Top view (horizontal range at maximum zoom-out)

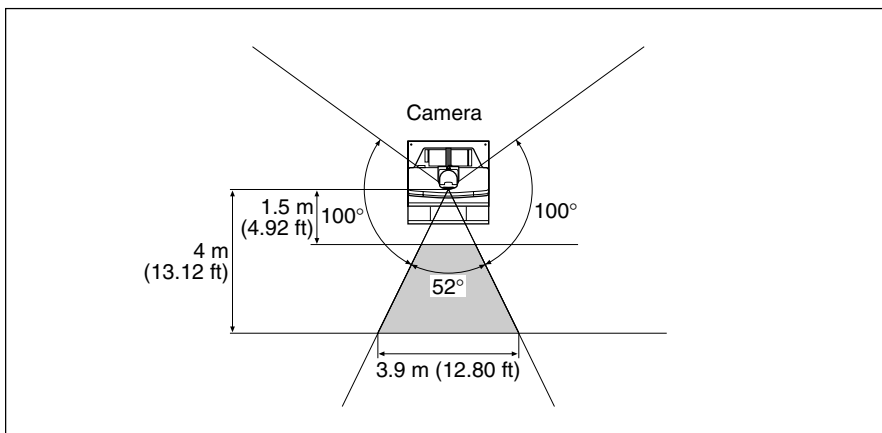

# Videomeeting Room Layout

## Side view (vertical range at maximum zoom-out)

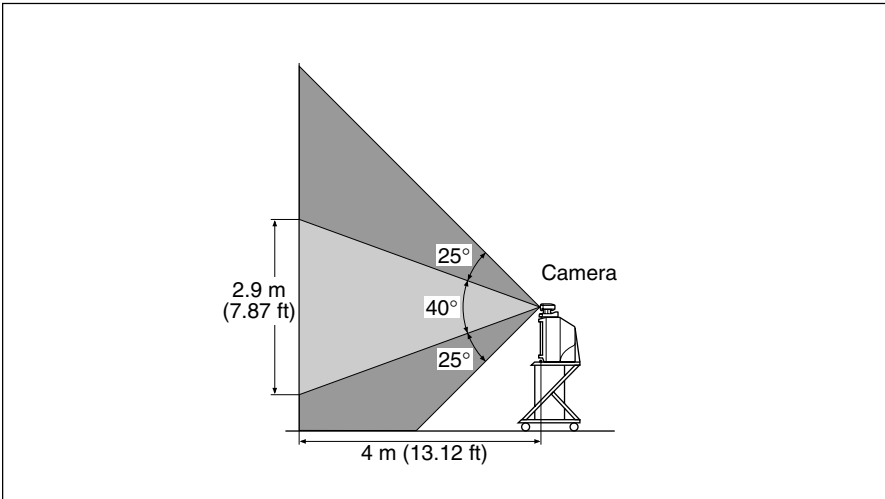

## Layout Considerations

- Avoid allowing large, moving objects, especially people behind the participants; the quality of the local transmission will deteriorate.
- Do not seat participants in front of a wall with fine line patterns.
- Choose a place which is echo-free.
- Do not install the system near noise sources such as air conditioners or copy machines.
- Avoid placing the system in a room where there are speakers used for an in-house broadcasting system.

---

## Lighting Considerations

Do not point the camera towards a window as back lighting may wash out the contrast. Cover any windows with a thick curtain.

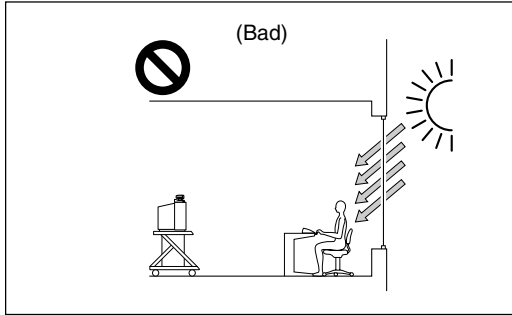

Adjust room lighting so that it falls on the participants. Avoid direct light on the TV monitor. Light intensity on faces should be about 300 lux or more.

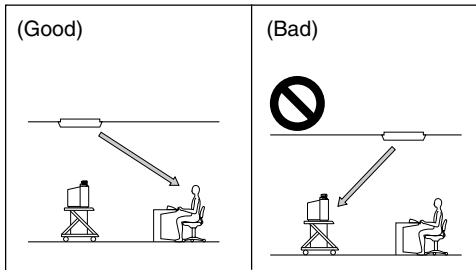

If an inverter type or brightness-adjustable type of fluorescent lamp is used, the sensitivity of the Remote Commander may deteriorate.

# Glossary

## **Bonding**

An abbreviation for Bandwidth on Demand Interoperability.

## **BRI**

An abbreviation for Basic Rate Interface. Single ISDN has two B-channels and one D-channel.

## **CIF**

An abbreviation for Common Intermediate Format. This format allows to communicate with between different color systems (NTSC or PAL).

352 pixels × 288 lines

## **Codec**

An abbreviation for Coder-Decoder. An electronic device that converts an analog signal (such as voice or video) to a digital data stream, compresses it, and sends it over a digital communications line. Another codec reverses the process at the receiving end.

## **DHCP**

An abbreviation for Dynamic Host Configuration Protocol. Manages IP addresses in the network.

## **DNS**

An abbreviation for Domain Name System.

## **Echo**

Reflection of sound from walls and other surrounding objects.

## **Frame rate**

The number of frames which can be encoded/decoded in one second.

## **G.711**

Pulse code modulation (PCM) of voice frequencies.

## **G.722**

7 kHz audio-coding within 64 Kbps.

## **G.723.1**

5.3 or 6.3 kHz audio-coding within 32 Kbps.

## **G.728**

Coding of speech at 16 Kbps using low-delay code excited linear prediction.

## **Gatekeeper**

Controls the access of H.323 videoconference devices on a network. Administers the zone, access limitation, audio/video bandwidth, and alias etc.

## **H.221**

Frame structure for a 64 to 1920 Kbps channel in audiovisual teleservices.

## **H.261**

Video codec for audiovisual services as p × 64 Kbps.

## **H.263**

This is basically based on H.261, however, this enables communication using via a lower bit rate.

## **H.320**

Narrow-band visual telephone systems and terminal equipment.

## **H.323**

This enables communications on the non-QOS (Quality of Service) LAN.

## **Interface**

A device that goes between two different devices so that they can communicate with each other.

## **I-MUX**

An abbreviation for Inverse Multiplexer. This protocol allows you to transmit the data at 384 Kbps via 6B-channel.

## **ISDN**

An acronym for Integrated Services Digital Network. This is a communications protocol by CCITT on transmission of integrated voice, video, and data. Bandwidths include basic (64 Kbps) and primary rate (1.544 and 2.048 Mbps).

## **ITU-T**

An abbreviation for International Telecommunication Union, Telecommunications.

## **Lip synchronization**

A function that synchronizes sound with motion. Sound processing is much faster than motion processing, thus sound and motion sometimes get out of step with each other.

## **MCU**

An abbreviation for Multipoint Control Unit. When connecting a MCU, a multipoints meeting can be held.

## **PBX**

An abbreviation for Private Branch eXchange.

---

**P in P**

An abbreviation for “Picture in Picture.” This is a function which allows the user, to monitor their own party on a small window on the TV monitor.

**QCIF**

An abbreviation for Quater CIF. The number of pixels is a quarter than one of CIF format.  
176 pixels × 144 lines

**SNMP**

An abbreviation for Simple Network Management Protocol. This protocol is for management information between the management station and the managed terminals.

**SPID**

An abbreviation for Service Profile ID.

**Still picture**

Still, unmoving pictures, as in a photograph.

**Sub-address**

An identification number given to devices sharing a common ISDN line .

**Terminal adaptor**

A device used to connect various equipment to a digital line. The device sits between the equipment and the digital line and checks that signals are correctly sent or received.

**V.35**

This interface is frequently used for data communication since this transmits data at high speed.

