



ES30C/ES31C Series Esprit[®] with IOP



C309M-J (9/04)

CONTENTS

<u>Section</u>	<u>Page</u>
IMPORTANT SAFETY INSTRUCTIONS	5
OPERATION	6
POWER-UP DISPLAY	6
HOW TO OPERATE YOUR SYSTEM	6
OPERATING NOTES	7
ENVIRONMENTAL RANGE	7
PAN AND TILT FUNCTIONS	7
SCAN SPEED	7
PRESET FUNCTIONS	7
RANDOM, FRAME, AND AUTO SCANNING	7
ZONES	7
PATTERNS	8
PARK	8
IR FILTER (MODELS ES30CBW18 AND ES31CBW18 ONLY)	8
AUTO IRIS	8
WIPER	8
OPEN COLLECTOR AUXILIARY OUTPUT	8
PROGRAMMING - ES30C16/ES31C16	9
PROGRAMMING - ES30C22/ES31C22	10
PROGRAMMING - ES30CBW18/ES31CBW18	11
PROGRAMMING	12
ACCESSING MAIN MENU (PRESET 95)	12
AUTO FOCUS MODE	13
AUTO IRIS	14
AUTO IR LEVEL (MODELS ES30CBW18/ES31CBW18 ONLY)	15
AUTO SHARPNESS	16
AZ/EL	17
AZ/EL LINE	18
AZIMUTH ZERO	19
BACKLIGHT COMPENSATION	20
DIRECTION	21
DIRECTION LINE	22
DISPLAY DURATION	23
GAIN/AGC	24
GAIN LIMIT	24
IR FILTER MODE (MODELS ES30CBW18/ES31CBW18 ONLY)	25
LIMIT STOPS	26
TURNING LIMIT STOPS ON OR OFF	26
PROGRAMMING LIMIT STOPS	26
MANUAL LIMIT STOPS	26
SCAN LIMIT STOPS	28
LINE SYNCHRONIZATION	29
LOWLIGHT LIMIT (MODELS ES30C22/ES31C22 AND ES30CBW18/ES31CBW18 ONLY)	30
PARK TIME MINUTES	31
PATTERN LENGTH	32
POWER-UP MODE	33
PROPORTIONAL PAN	34
RESET CAMERA	35
SCAN SPEED	36
SHARPNESS	37
SHUTTER SPEED	38
SPEED PROFILE	39

WHITE BALANCE	40
WIPER MODE	41
ZONE BLANK	42
ZONES	42
ZOOM	43
ZOOM LIMIT	44
ZOOM LINE	45
SPECIFICATIONS	46
REGULATORY NOTICES	49

IMPORTANT SAFETY INSTRUCTIONS

1. Read these instructions.
2. Keep these instructions.
3. Heed all warnings.
4. Follow all instructions.
5. Do not block any ventilation openings. Install in accordance with the manufacturer's instructions.
6. Do not install near any heat sources such as radiators, heat registers, stoves, or other apparatus (including amplifiers) that produce heat.
7. Only use attachments/accessories specified by the manufacturer.
8. Use only with the cart, stand, tripod, bracket, or table specified by the manufacturer, or sold with the apparatus. When a cart is used, use caution when moving the cart/apparatus combination to avoid injury from tip-over.
9. Refer all servicing to qualified service personnel. Servicing is required when the apparatus has been damaged in any way, such as power-supply cord or plug is damaged, liquid has been spilled or objects have fallen into the apparatus, the apparatus has been exposed to rain or moisture, does not operate normally, or has been dropped.
10. Installation should be done only by qualified personnel and conform to all local codes.
11. Unless the unit is specifically marked as a NEMA Type 3, 3R, 3S, 4, 4X, 6, or 6P enclosure, it is designed for indoor use only and it must not be installed where exposed to rain and moisture.
12. Use only installation methods and materials capable of supporting four times the maximum specified load.
13. Use stainless steel hardware to fasten the mount to outdoor surfaces.
14. To prevent damage from water leakage when installing a mount outdoors on a roof or wall, apply sealant around the bolt holes between the mount and mounting surface.
15. AN ALL-POLE MAINS SWITCH with a contact separation of at least 3 mm in each pole shall be incorporated in the electrical installation of the building.
16. A readily accessible disconnect device shall be incorporated in the building installation wiring.

CAUTION: These servicing instructions are for use by qualified service personnel only. To reduce the risk of electric shock do not perform any servicing other than that contained in the operating instructions unless you are qualified to do so.

Only use replacement parts recommended by Pelco.

After replacement/repair of this unit's electrical components, conduct a resistance measurement between the line and exposed parts to verify the exposed parts have not been connected to the line circuitry.

The product and/or manual may bear the following marks:



This symbol indicates that dangerous voltage constituting a risk of electric shock is present within this unit.



This symbol indicates that there are important operating and maintenance instructions in the literature accompanying this unit.



WARNING: HAZARDOUS MOVING PARTS. KEEP FINGERS AND OTHER BODY PARTS AWAY.

CAUTION:
RISK OF ELECTRIC SHOCK. DO NOT OPEN.

OPERATION

POWER-UP DISPLAY

When the system is powered up, the selected protocol, revision number, and other information is displayed on the monitor. For example, the screen might show the following information:

```
ESPRIT 16X IOP 1.0h
CONFIGURE DONE

D Address 1
P Address 2
Comm 2400, N, 8, 1

CAMERA XXXX-XXXX
```

The information displayed depends on the selected protocol (C, D, or P) and the menu selection for power-up mode. (Refer to the *Power-Up Mode* in the *Programming* section).

The information remains on the monitor until the system is moved.

HOW TO OPERATE YOUR SYSTEM

Operation	How to Control
Pan and Tilt	Move joystick left/right and up/down.
Scanning Stop scan Random scan Frame scan Auto scan	Call preset 96. Call preset 97. Call preset 98. Call preset 99.
Zoom Far	To zoom far, do the following: 1. Press the Zoom Tele button or turn the joystick clockwise until zoom stops at the optical zoom¹ limit . 2. Release the button or joystick. 3. To continuing zooming (digitally), immediately press the button or turn the joystick clockwise again until you have the picture you want or reach the digital zoom² limit .
Zoom Wide	Press the Zoom Wide button or turn the joystick counterclockwise.
Presets	Refer to the documentation supplied with the controller.
Patterns	Refer to the documentation supplied with the controller.

¹ Optical zoom magnifies the image and the picture remains clear. Resolution is constant.

² Digital zoom magnifies the image and the picture may appear pixilated. The larger the zoom limit the greater the reduction in resolution.

OPERATING NOTES

ENVIRONMENTAL RANGE

The operating temperature ranges from a minimum of -50°F (-45°C) to a maximum of 122°F (50°C) for sustained system operation or 140°F (60°C) absolute maximum. The entire unit can de-ice and be operational in two hours from a temperature of -13°F (-25°C). The thermostatically controlled heater consumes 10 watts and cycles on at 70°F (21°C) and off at 85°F (29°C), while the window defroster runs continuously and consumes 2.5 watts.

PAN AND TILT FUNCTIONS

Controller Type	Pan (Capability – 360° Continuous Pan Rotation)**	Tilt (Viewing Range – +33° to -83°)***
Fixed speed	Speed determined by controller	Speed determined by controller
*Variable speed	0.1 to 40° per second, depending on joystick and zoom positions	0.1 to 20° per second, depending on joystick and zoom positions
*Turbo Mode	100° per second	Does not affect the tilt speed
*Preset Mode	100° per second	30° per second

* 50 mph wind-speed profile.

** If manual limit stops are set, "Pan Limit" appears on your monitor when a limit stop is reached (except when you are programming or running a pattern). This does not apply to scan limit stops.

*** When the system reaches the upper limit, "Tilt Limit" appears on your monitor (except when you are programming or running a pattern).

If the proportional pan mode is enabled (refer to the *Proportional Pan* in the *Programming* section), the pan and tilt speeds will depend on the amount of zoom. At telephoto zoom settings, the pan and tilt speeds will be slower for a given amount of joystick deflection than at wide zoom settings. This keeps the image from moving too fast on the monitor when there is a large amount of zoom. This slowing does not happen when going to a preset but does occur in turbo mode when high zoom is selected. The minimum pan and tilt speeds are 0.1 degree per second at full zoom.

SCAN SPEED

Scan speed is adjustable from 1 to 40 degrees per second through the programming menu.

PRESET FUNCTIONS

The Esprit® system is capable of going to 64 preset locations, each with a 20-character label. The presets are numbered 1-32 and 35-66. Refer to the documentation for your control system for programming presets.

If you command the pan and tilt to go to an undefined preset, erratic operation may result.

Presets 33 and 34 are fixed commands, meaning that you cannot program them. Preset 33 is the "flip" command, which will pan the system 180 degrees. Preset 34 is the "pan zero" command, which will pan the system to the factory-determined zero reference point.

RANDOM, FRAME, AND AUTO SCANNING

Select preset 97 (30) to start random scanning. Select preset 98 (31) to activate frame scanning (three seconds of scanning followed by a three-second pause). Select preset 99 (32) to start auto (continuous) scanning. Scan limit stops are controlled by software. Refer to the *Limit Stops* section to program the scan limit stops.

When the pan and tilt reaches a scan limit stop, it reverses direction. Select preset 96 (29) to stop a scan. Any pan and tilt or lens command also will stop a scan.

ZONES

A zone is a programmed pan area with set boundaries and identifying label. The Esprit system has a maximum of eight zones, each with a 20-character label. Zones can be programmed to blank video when the camera pans into the zone area. If a zone is blanked, the system displays the message, VIDEO BLANK. (Refer to *Zone Blank* in the *Programming* section for instructions.)

PATTERNS

The Esprit system can do either one full pattern (1.5, 3, or 6 minutes long) or two half patterns (.75, 1.5, or 3 minutes long). This pattern can consist of any standard pan and tilt or lens command. Presets, flip, digital zoom, proportional pan, and turbo are not allowed in a pattern. Zones can be enabled while running a pattern. Refer to the documentation for your control system to program and run patterns.

PARK

If the system does not receive any commands for a specified period of time (refer to the *Park Time Minutes* section), the system goes to preset 1 and parks. If the time specified is zero, or if preset 1 has not been programmed, the pan and tilt will not park.

IR FILTER (MODELS ES30CBW18 AND ES31CBW18 ONLY)

The ES30CBW18 and ES31CBW18 models have an IR (infrared) lens filter that can switch in and out, automatically or manually, depending on how the system is programmed. When the filter is IN, the camera produces a color picture. When the IR filter switches OUT, the picture changes to black and white, increasing visibility in low light conditions.

The Auto IR Level setting controls automatic operation of the filter. To manually override automatic operation, use presets 88 (filter IN) and 89 (filter OUT). The unit will remain in manual control until it is panned or tilted more than 15 degrees.

LOW LIGHT does not mean NO LIGHT. Some type of illumination is required (street light, IR light, etc.).

AUTO IRIS

If auto iris is in the auto mode, it remains that way until you manually open or close the iris. The system will return to auto iris when it is panned or tilted more than 15 degrees.

WIPER

The ES31C Series features a window wiper to clear moisture from the enclosure glass. There are two modes of operation for the wiper, momentary and continuous. The wiper mode is easily set up through on-screen programming (refer to the *Wiper Mode* section).

To operate the wiper do the following:

Momentary Mode – To operate the wiper one full cycle, press the AUX 1 button on your controller. Each press of the button operates the wiper one full cycle, even if the AUX 1 button is latching. If AUX 1 is latching, the first press will activate the wiper (open the latch). Pressing AUX 1 a second time closes the latch, but will not cycle the wiper. Press the AUX 1 key again to cycle the wiper.

Continuous Mode – To operate the wiper press the AUX 1 button on your controller. The wiper will continue to operate until the AUX 1 button is pressed again or until the programmed cycle is completed.

NOTE: CM9740 and CM9760 Matrix Systems Only – For the wiper to operate in continuous mode, the AUX 1 function in the camera file must be set to latching. If the AUX 1 camera file is not latching, the wiper will only operate in momentary mode, even if the Esprit wiper is programmed for continuous operation. Refer to the operation manual supplied with the CM9740 or CM9760 matrix system for instructions.

OPEN COLLECTOR AUXILIARY OUTPUT

An AUX 2 command from the controller will activate a device, such as a relay. The output will remain active for two seconds and then deactivate, even if the controller is set to latching mode.

Examples of devices that can be used with AUX 2 are a washer assembly (not supplied by Pelco) or a latching relay (not supplied by Pelco) attached to control a gate, lights, etc.

If a relay is used it must require less than 32 VDC and 40 mA to trigger the relay coil. The relay must be placed within 100 feet (30 m) of the Esprit unit.

PROGRAMMING - ES30C16/ES31C16

1. Access main menu (preset 95).
2. Make main menu selections.
 Joystick: Move up or down to position cursor or to toggle between selections.
 Iris Open: Enter.
 Iris Close: Cancel.

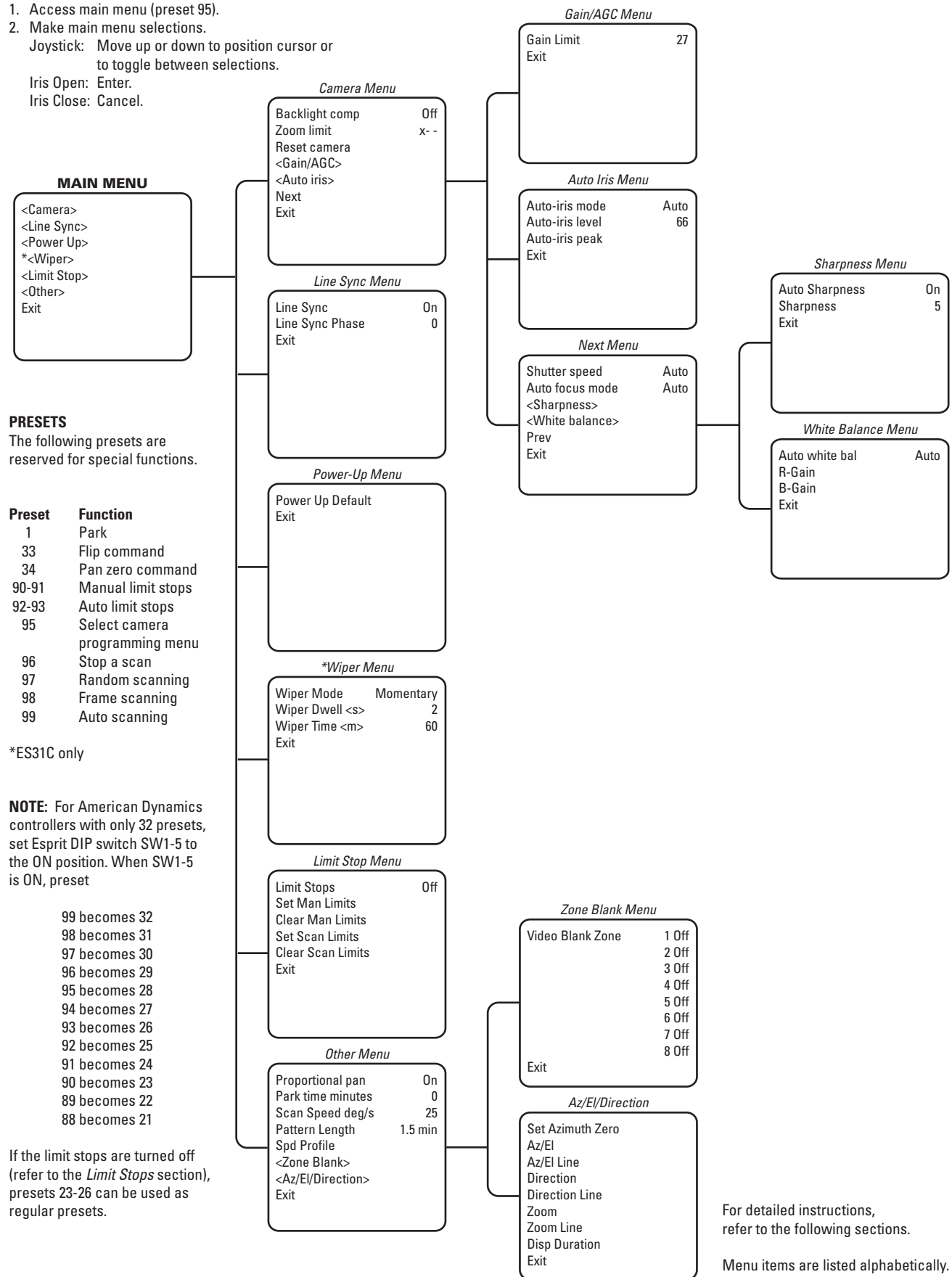

PRESETS
 The following presets are reserved for special functions.

Preset	Function
1	Park
33	Flip command
34	Pan zero command
90-91	Manual limit stops
92-93	Auto limit stops
95	Select camera programming menu
96	Stop a scan
97	Random scanning
98	Frame scanning
99	Auto scanning

*ES31C only

NOTE: For American Dynamics controllers with only 32 presets, set Esprit DIP switch SW1-5 to the ON position. When SW1-5 is ON, preset

- 99 becomes 32
- 98 becomes 31
- 97 becomes 30
- 96 becomes 29
- 95 becomes 28
- 94 becomes 27
- 93 becomes 26
- 92 becomes 25
- 91 becomes 24
- 90 becomes 23
- 89 becomes 22
- 88 becomes 21

If the limit stops are turned off (refer to the *Limit Stops* section), presets 23-26 can be used as regular presets.

For detailed instructions, refer to the following sections.

Menu items are listed alphabetically.

PROGRAMMING - ES30C22/ES31C22

1. Access main menu (preset 95).
2. Make main menu selections.
 Joystick: Move up or down to position cursor or to toggle between selections.
 Iris Open: Enter.
 Iris Close: Cancel.

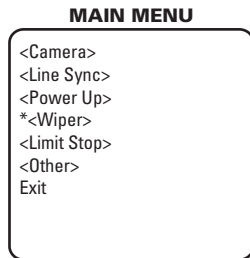

PRESETS

The following presets are reserved for special functions.

Preset	Function
1	Park
33	Flip command
34	Pan zero command
90-91	Manual limit stops
92-93	Auto limit stops
95	Select camera programming menu
96	Stop a scan
97	Random scanning
98	Frame scanning
99	Auto scanning

*ES31C only

NOTE: For American Dynamics controllers with only 32 presets, set Esprit DIP switch SW1-5 to the ON position. When SW1-5 is ON, preset

- 99 becomes 32
- 98 becomes 31
- 97 becomes 30
- 96 becomes 29
- 95 becomes 28
- 94 becomes 27
- 93 becomes 26
- 92 becomes 25
- 91 becomes 24
- 90 becomes 23
- 89 becomes 22
- 88 becomes 21

If the limit stops are turned off (refer to the *Limit Stops* section), presets 23-26 can be used as regular presets.

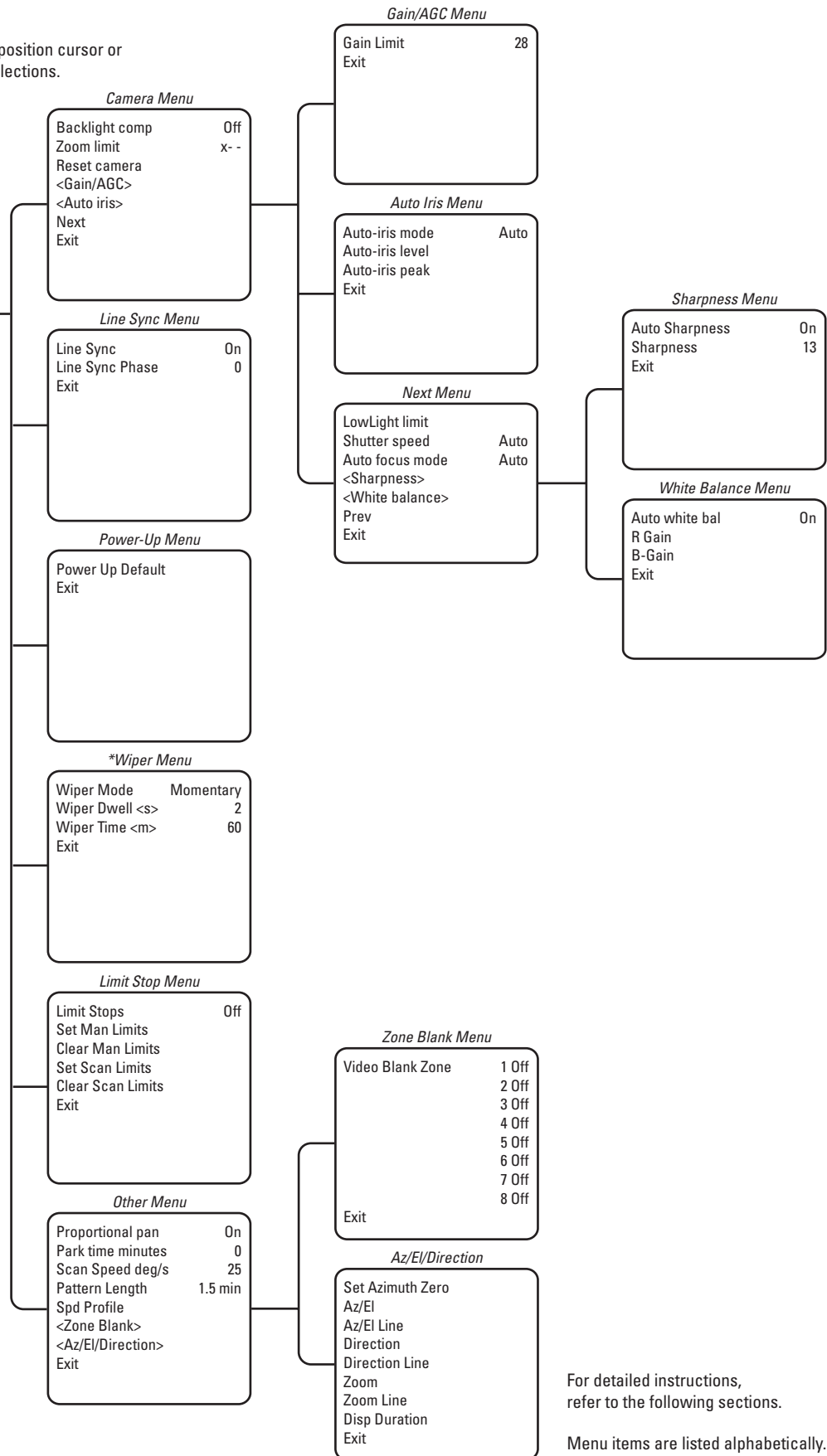

For detailed instructions, refer to the following sections.

Menu items are listed alphabetically.

PROGRAMMING - ES30CBW18/ES31CBW18

1. Access main menu (preset 95).
2. Make main menu selections.
 Joystick: Move up or down to position cursor or to toggle between selections.
 Iris Open: Enter.
 Iris Close: Cancel.

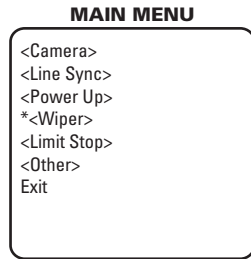

PRESETS

The following presets are reserved for special functions.

Preset	Function
1	Park
33	Flip command
34	Pan zero command
88	IR filter IN
89	IR filter OUT
90-91	Manual limit stops
92-93	Auto limit stops
95	Select camera programming menu
96	Stop a scan
97	Random scanning
98	Frame scanning
99	Auto scanning

*ES31C only

NOTE: For American Dynamics controllers with only 32 presets, set Esprit DIP switch SW1-5 to the ON position. When SW1-5 is ON, preset

- 99 becomes 32
- 98 becomes 31
- 97 becomes 30
- 96 becomes 29
- 95 becomes 28
- 94 becomes 27
- 93 becomes 26
- 92 becomes 25
- 91 becomes 24
- 90 becomes 23
- 89 becomes 22
- 88 becomes 21

If the limit stops are turned off (refer to the *Limit Stops* section), presets 23-26 can be used as regular presets.

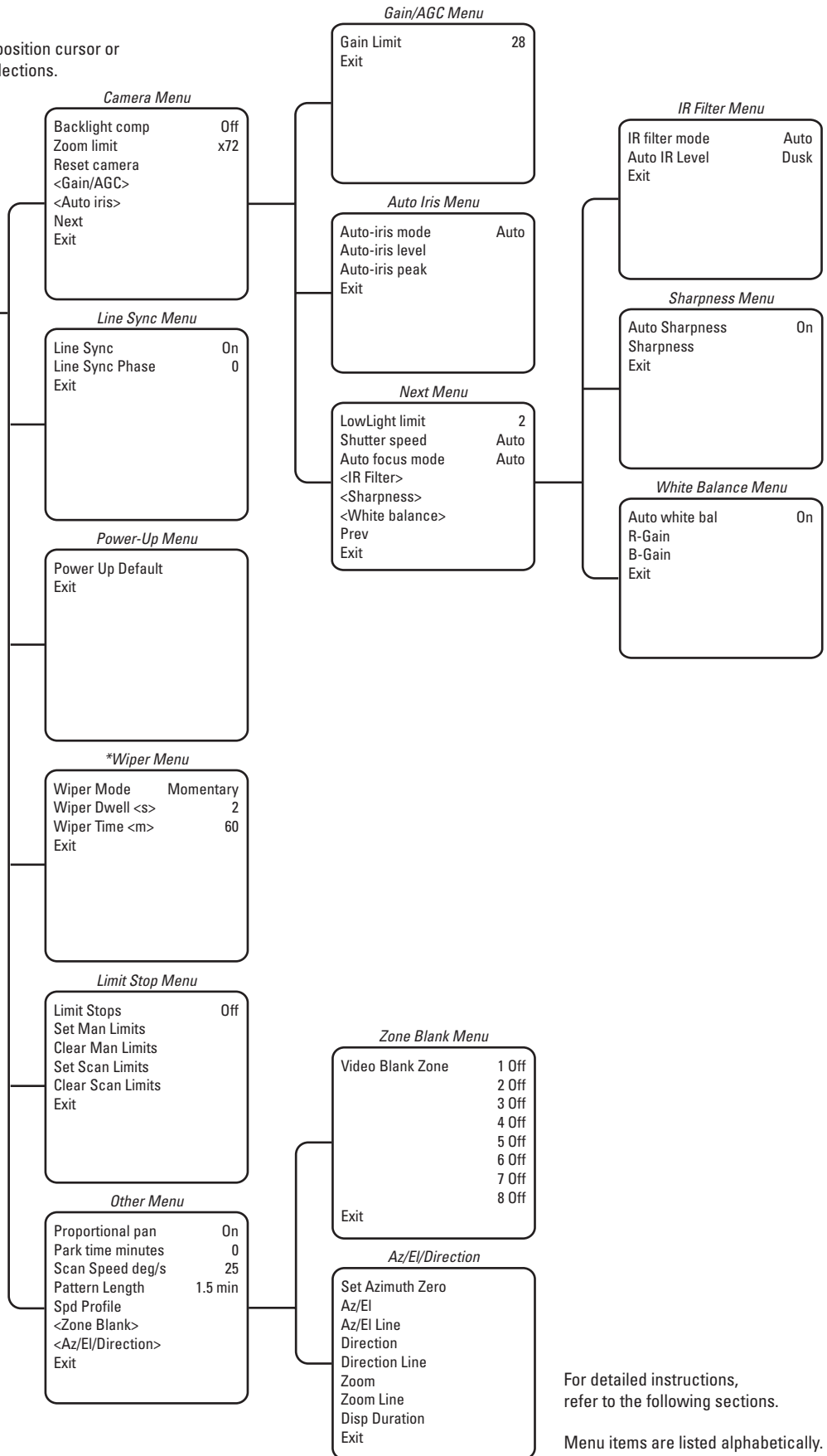

For detailed instructions, refer to the following sections.

Menu items are listed alphabetically.

PROGRAMMING

ACCESSING MAIN MENU (PRESET 95)

You can call up the main menu on your monitor by programming (setting or creating) preset 95 (28 if in 32-preset mode).

Programming preset 95 for Pelco's controllers varies according to the type of controller you are using. Instructions for programming preset 95 are given below for various Pelco controllers.

CM6700

1. Enter the number of the camera and press the CAM key.
2. Enter 95 and hold the PRESET key for two seconds.
3. In the Edit Preset menu, arrow to SET and press the ACK key. The main menu appears.

KBD200A/KBD300A (Direct Mode Only)

1. Enter 95.
2. Hold the PRESET key (approximately 5 seconds) until the main menu appears on the screen.

CM8500

1. Enter the number of the camera and press the CAM key.
2. Highlight PRESET in the Camera menu and hold down the joystick button until the Set Presets prompt appears.
3. Enter 95 and press the PRESET key. The text editor appears. Select ENTER and the main menu appears.

CM9500

1. Enter the number of the camera and press the CAM key. The Main menu appears.
2. Highlight SETUP in the Main menu and press the SELECT key.
3. Highlight CAM in the Setup menu and press the SELECT key.
4. Highlight PRESET in the Camera menu and press the SELECT key.
5. Enter 95 and press the F1 key. The main menu appears.

CM9750

1. Turn the KEY SWITCH to the ON position.
2. Press the PROG key. PROGRAM appears on the LCD display.
3. Press the PRES key. The PRESET prompt appears.
4. Enter 95 and press the ENTER key. The main menu appears.
5. Turn the KEY SWITCH to the OFF position.

CM9740/CM9760/CM9770

1. Press the ESCAPE key to open the Main menu. Select DEF. The Define Menu appears.
2. Enter your four-digit PIN **if this is your first time entering this mode**.
3. Enter 95 and select PRST. The main menu appears on the monitor.
4. Select the Quit icon to return to the default menu.

KBD4000/KBD4002/KBD4000V

1. Press the SPOT MONITOR key.
2. Enter 95, and then hold the PRESET key (approximately five seconds) until the main menu appears on the screen.

MPT9500

Standard Coaxitron® Mode

1. Enter 95 and press the PRESET SET key.
2. Position the asterisk in the YES row and press the F1 key. The main menu appears.

Extended Coaxitron or RS-485 Mode

1. Enter 95 and press the PRESET SET key.
2. Press the F2 key. The main menu appears.

AUTO FOCUS MODE

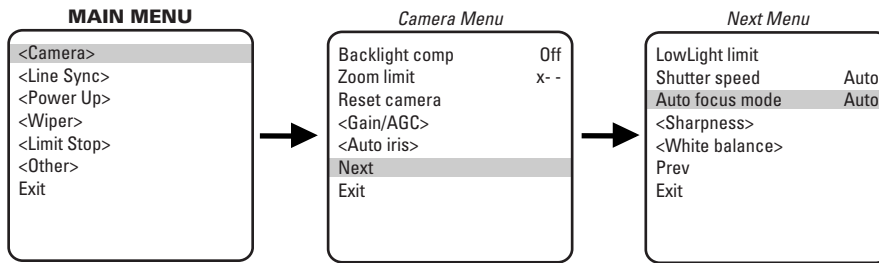

There are two auto focus modes:

Auto – If auto focus is in the auto mode, pressing the Focus Far or Focus Near button will place the focus in the manual mode. The system will return to auto focus if you pan or tilt the unit or do a zoom function.

Off – If the mode is set to off, the system will operate in the manual mode with one exception. If you issue a command to go to a preset, auto focus will turn on and remain on until you press the Focus Far or Focus Near button.

NOTE: Auto focus does not operate at shutter speeds longer than 1/8 of a second.

To change the mode:

1. Program preset 95 (28). The main menu appears.
2. Position the cursor (>) beside Camera.
3. Press the Iris Open button to enter the Camera menu.
4. Position the cursor (>) beside Next.
5. Press the Iris Open button to go to the next camera menu.
6. Position the cursor (>) beside Auto Focus Mode.
7. Press the Iris Open button. The cursor moves to the right, beside the word Auto or Off.
8. Move the joystick up or down to toggle between Auto and Off.
9. **SELECT** – Press the Iris Open button on your keyboard to select your choice.
CANCEL – Press the Iris Close button if you do not want to change the setting.

AUTO IRIS

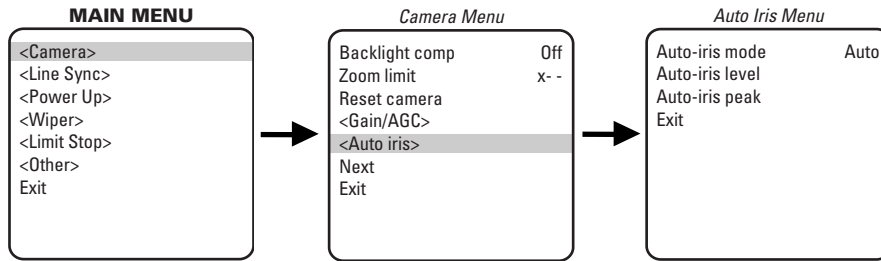

The following are the settings for auto iris:

Mode
Level
Peak

To change the settings for auto iris:

1. Program preset 95 (28). The main menu appears.
2. Position the cursor (>) beside Camera.
3. Press the Iris Open button to enter the Camera menu.
4. Position the cursor (>) beside Auto Iris.
5. Press the Iris Open button. The Auto Iris menu appears.
6. Position the cursor (>) and select one of the following settings:

MODE – The cursor moves to one of two choices:

Auto – The iris is automatically adjusted to produce a constant video output as determined by the Level setting.
Off – Auto iris is disabled, and control is always manual.

Move the joystick up or down to toggle between Auto and Off. Press the Iris Open button to select the choice, or press the Iris Close button if you do not want to change the setting.

LEVEL – The cursor moves to a numeric value, which the system uses to try to maintain a certain light level. Changing the value of the Level setting will change the video level to which the auto iris adjusts. This setting should be adjusted if the video level in the auto iris mode is too bright or too dark. Move the joystick up or down to a value. Press the Iris Open button to select the value, or press the Iris Close button if you do not want to change the setting.

PEAK – The cursor moves to a numeric value. Increasing this value will cause the auto iris circuit to react more to highlights or “peaks” in the picture. Decreasing this value will cause it to use the average video level to adjust the iris. Move the joystick up or down to a value. Press the Iris Open button to select the value, or press the Iris Close button if you do not want to change the setting.

AUTO IR LEVEL (MODELS ES30CBW18/ES31CBW18 ONLY)

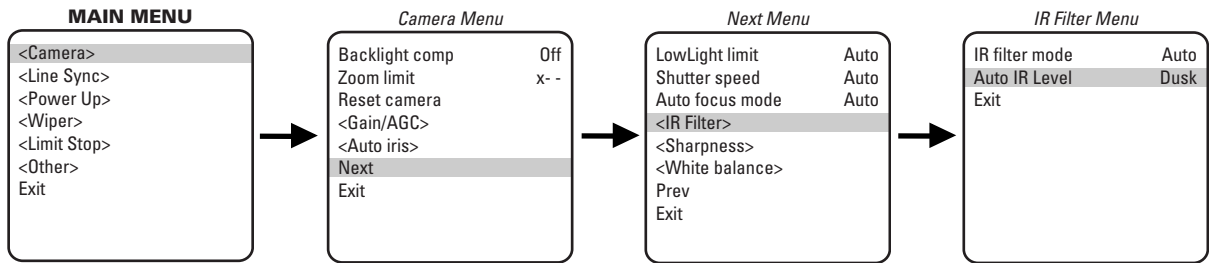

The auto IR level is the light level at which the infrared filter switches IN or OUT. Following are the available settings for the Auto IR Level:

DUSK (default) – approximately 6 lux (black-white) approximately 13 lux (color)

DARK – approximately 0.1 lux (black-white) approximately 2 lux (color)

NOTE: If backlight compensation is ON and the IR cut filter switches OUT in normal lighting conditions, adjust the Auto IR Level to a darker setting. Refer to the Backlight Compensation section.

NOTE: LOW LIGHT does not mean NO LIGHT. Some type of illumination is required (street light, IR light, etc.). The camera is not sensitive to IR light when the IR cut filter is IN.

To change the auto IR level settings:

1. Program preset 95 (28). The main menu appears.
2. Position the cursor (>) beside Camera.
3. Press the Iris Open button to enter the Camera menu.
4. Position the cursor (>) beside Next.
5. Press the Iris Open button to enter the Next menu.
6. Position the cursor (>) beside IR Filter.
7. Press the Iris Open button to enter the IR Filter menu.
8. Position the cursor (>) beside Auto IR Level.
9. Press the Iris Open button. The cursor moves to the right.
10. Move the joystick up or down to toggle between the level settings.
11. SELECT – Press the Iris Open button on your keyboard to select your choice.
CANCEL – Press the Iris Close button if you do not want to change the setting.

AUTO SHARPNESS

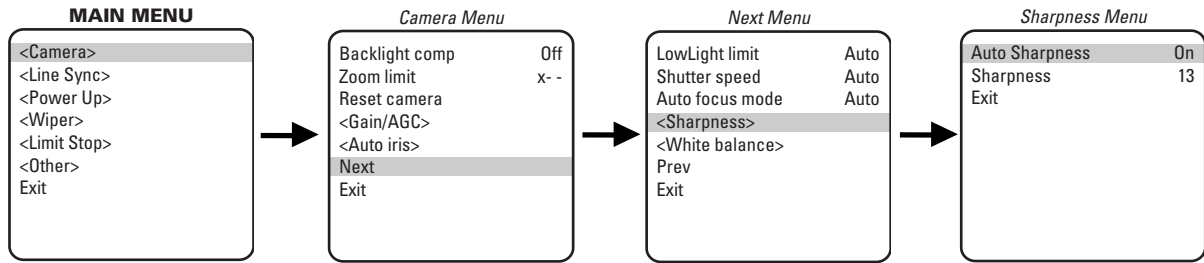

The following settings are available for auto sharpness:

On – Automatically sets the sharpness of the camera.
Off – The sharpness of the camera needs to be manually set (refer to *Sharpness*).

To change the mode:

1. Program preset 95 (28). The main menu appears.
2. Position the cursor (>) beside Camera.
3. Press the Iris Open button to enter the Camera menu.
4. Position the cursor (>) beside Next. Press the Iris Open button to go to the next camera menu.
5. Position the cursor (>) beside Sharpness. Press the Iris Open button.
6. Position the cursor (>) beside Auto Sharpness. Press the Iris Open button the cursor moves to the right.
8. Move the joystick up or down to toggle between On and Off.
9. SELECT – Press the Iris Open button on your keyboard to select your choice.
CANCEL – Press the Iris Close button if you do not want to change the setting.

AZ/EL

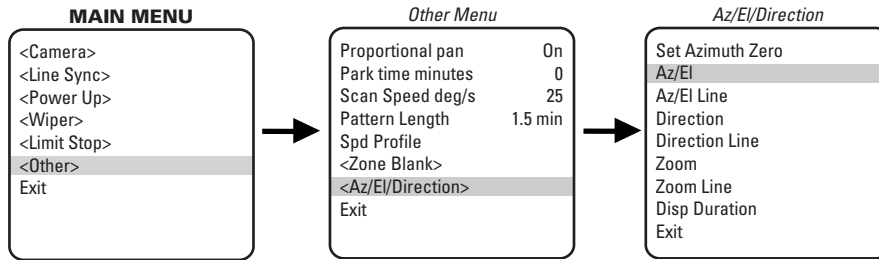

Az/El programs the horizontal display position of the Azimuth¹/Elevation² label.

NOTE: Az/El display is not available while you are programming or running a pattern.

The following settings are available for the Az/El label:

- Off – Label is not displayed.
- Left (default) – Label is displayed on the left-hand side of the screen.
- Center – Label is displayed in the center of the screen.
- Right – Label is displayed on the right-hand side of the screen.

To program the horizontal label position for Az/El:

1. Program preset 95 (28). The main menu appears.
2. Position the cursor (>) beside Other.
3. Press the Iris Open button to enter the Other menu.
4. Position the cursor (>) beside Az/El/Direction.
5. Press the Iris Open button to enter the Az/El/Direction menu.
6. Position the cursor (>) beside Az/El.
7. Press the Iris Open button. The cursor moves to the right.
8. Move the joystick up or down to view the available selections.
9. SELECT – Press the Iris Open button to make a selection.
CANCEL – Press the Iris Close button to cancel selection.

¹ Azimuth is the pan angle from 0° to 359°.

² Elevation is the tilt position from 33° to -83°.

AZ/EL LINE

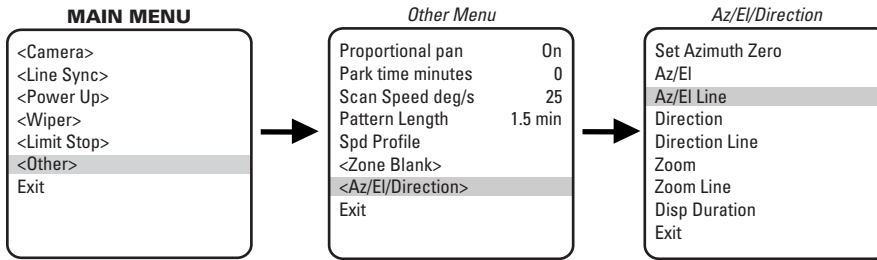

Az/El Line controls the vertical display position of the Azimuth/Elevation label. The label may be displayed on lines 3 through 10. Line 3 is the third line from the top of the screen and line 10 is located at the bottom of the screen. Line 10 is the default setting.

NOTE: Az/El display is not available while you are programming or running a pattern.

To program the vertical label position for Az/El:

1. Program preset 95 (28). The main menu appears.
2. Position the cursor (>) beside Other.
3. Press the Iris Open button to enter the Other menu.
4. Position the cursor (>) beside Az/El/Direction.
5. Press the Iris Open button to enter the Az/El/Direction menu.
6. Position the cursor (>) beside Az/El Line.
7. Press the Iris Open button. The cursor moves to the right.
8. Move the joystick up or down to view the available selections.
9. SELECT – Press the Iris Open button to make a selection.
CANCEL – Press the Iris Close button to cancel a selection.

AZIMUTH ZERO

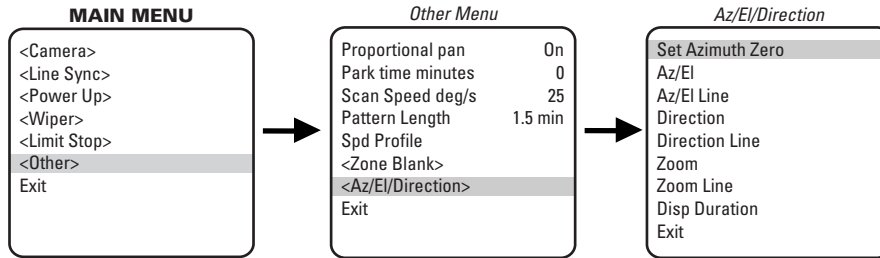

Azimuth is the pan angle from 0° to 359°. Azimuth zero is the programmed 0° point that is normally set to magnetic north. Once programmed, on-screen pan position (azimuth) and compass readings are based on the set azimuth zero point.

To set azimuth zero:

1. Program preset 95 (28). The main menu appears.
2. Position the cursor (>) beside Other.
3. Press the Iris Open button to enter the Other menu.
4. Position the cursor (>) beside Az/EI/Direction.
5. Press the Iris Open button to enter the Az/EI/Direction menu.
6. Position the cursor (>) beside Set Azimuth Zero.
7. Press the Iris Open button. The programming menu for Set Azimuth Zero appears on the monitor.
8. Use the joystick to pan the Esprit unit to the desired azimuth zero (0° point) position.
9. Press the Iris Open button to set the azimuth zero position.

BACKLIGHT COMPENSATION

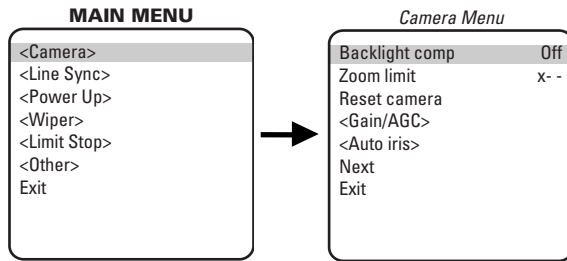

There are two backlight compensation modes:

On – The system uses the center 10 percent of the picture to adjust the iris. If there is a bright light source outside of this area, it will wash out to white. The camera will adjust the iris so that the object in the sensitive area is properly exposed.

NOTE: ES30CBW18/ES31CBW18 Only – If backlight compensation is ON and the IR cut filter switches OUT (black and white mode) **in normal lighting** conditions, adjust the Auto IR Level to a darker setting. Refer to the *Auto IR Level* section.

Off – Backlight compensation is not activated.

To change the backlight compensation mode:

1. Program preset 95 (28). The main menu appears.
2. Position the cursor (>) beside Camera.
3. Press the Iris Open button to enter the Camera menu.
4. Position the cursor (>) beside Backlight Comp.
5. Press the Iris Open button. The cursor moves to the right, beside the word On or Off.
6. Move the joystick up or down to toggle between On and Off.
7. SELECT – Press the Iris Open button on your keyboard to select your choice.
CANCEL – Press the Iris Close button if you do not want to change the setting.

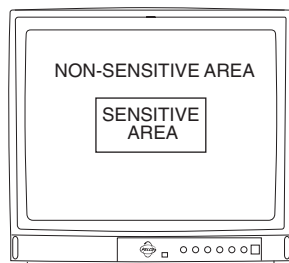

DIRECTION

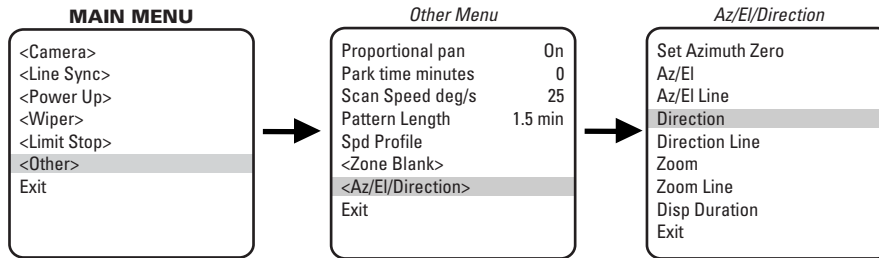

Direction programs the horizontal display position of the Direction label (N, NW, NE, ...).

NOTE: For direction to be accurate, the azimuth zero must be set to magnetic north.

NOTE: Direction display is not available while you are programming or running a pattern.

The following settings are available for the Direction label:

- Off – Label is not displayed.
- Left – Label is displayed on the left-hand side of the screen.
- Center – Label is displayed in the center of the screen.
- Right (default) – Label is displayed on the right-hand side of the screen.

To program the horizontal label position for Direction:

1. Program preset 95 (28). The main menu appears.
2. Position the cursor (>) beside Other.
3. Press the Iris Open button to enter the Other menu.
4. Position the cursor (>) beside Az/EI/Direction.
5. Press the Iris Open button to enter the Az/EI/Direction menu.
6. Position the cursor (>) beside Direction.
7. Press the Iris Open button. The cursor moves to the right.
8. Move the joystick up or down to view the available selections.
9. SELECT – Press the Iris Open button to make a selection.
CANCEL – Press the Iris Close button to cancel a selection.

DIRECTION LINE

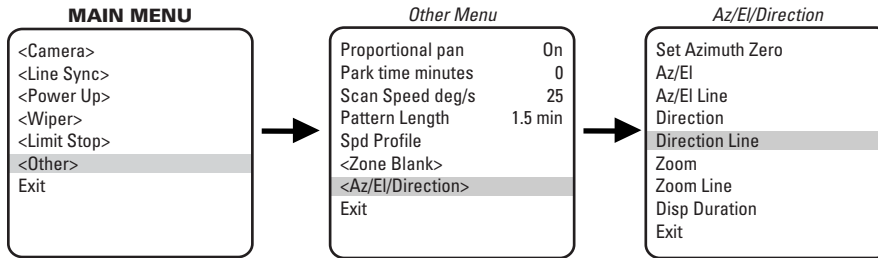

Direction Line controls the vertical display position of the Direction label. The label may be displayed on lines 3 through 10. Line 3 is the third line from the top of the screen and line 10 is located at the bottom of the screen. Line 10 is the default setting.

NOTE: Direction display is not available while you are programming or running a pattern.

To program the vertical label position for Direction:

1. Program preset 95 (28). The main menu appears.
2. Position the cursor (>) beside Other.
3. Press the Iris Open button to enter the Other menu.
4. Position the cursor (>) beside Az/EI/Direction.
5. Press the Iris Open button to enter the Az/EI/Direction menu.
6. Position the cursor (>) beside Direction Line.
7. Press the Iris Open button. The cursor moves to the right.
8. Move the joystick up or down to view the available selections.
9. **SELECT** – Press the Iris Open button to make a selection.
CANCEL – Press the Iris Close button to cancel selection.

DISPLAY DURATION

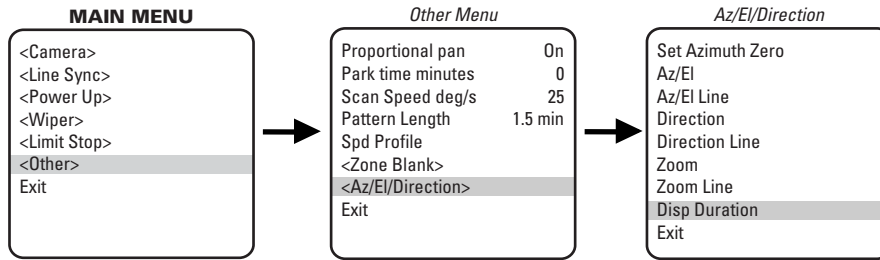

Display Duration programs the duration the Az/EI, Direction, and Zoom labels are displayed on the monitor. The available settings for display duration include the following:

- CONSTANT - The label is displayed continuously.
- 2 SECONDS (default) - The label is displayed for 2 seconds after PTZ functions end.
- 5 SECONDS - The label is displayed for 5 seconds after PTZ functions end.
- 10 SECONDS - The label is displayed for 10 seconds after PTZ functions end.

To program the display duration for the Az/EI, Direction, and Zoom labels:

1. Program preset 95 (28). The main menu appears.
2. Position the cursor (>) beside Other.
3. Press the Iris Open button to enter the Other menu.
4. Position the cursor (>) beside Az/EI/Direction.
5. Press the Iris Open button to enter the Az/EI/Direction menu.
6. Position the cursor (>) beside Disp Duration.
7. Press the Iris Open button. The cursor moves to the right.
8. Move the joystick up or down to view the available selections.
9. SELECT – Press the Iris Open button to make a selection.
CANCEL – Press the Iris Close button to cancel selection.

GAIN/AGC

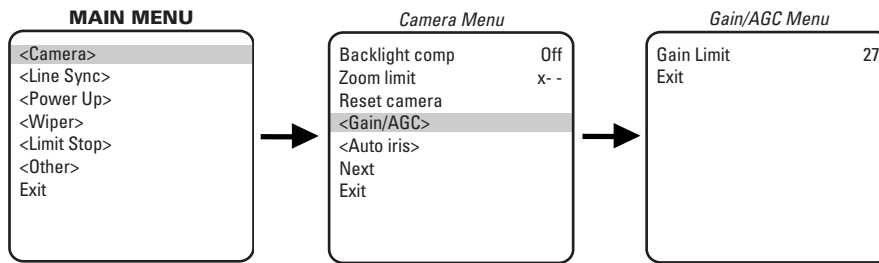

GAIN LIMIT

The gain limit sets the maximum level for the automatic gain control. Increasing the level will increase the signal level and increase the noise level of the picture.

To change the gain:

1. Program preset 95 (28). The main menu appears.
2. Position the cursor (>) beside Camera.
3. Press the Iris Open button to enter the Camera menu.
4. Position the cursor (>) beside Gain/AGC.
5. Press the Iris Open button to enter the Gain/AGC menu.
6. Position the cursor (>) beside Gain Limit.
7. Press the Iris Open button. The cursor moves to the right, beside the current gain level setting (a numeric value).
8. Move the joystick up or down to change the level.
9. **SELECT** – Press the Iris Open button on your keyboard to select your choice.
CANCEL – Press the Iris Close button if you do not want to change the setting.

IR FILTER MODE (MODELS ES30CBW18/ES31CBW18 ONLY)

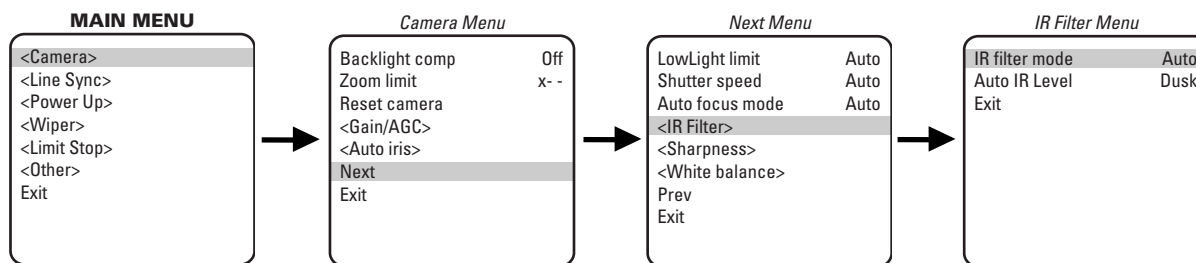

There are two settings for the IR filter mode:

Auto – IR filter switches in and out automatically.

IMPORTANT: Automatic shutter speed must be set to Auto for the IR filter to operate automatically. If the automatic shutter speed is disabled, the IR filter setting will automatically switch to OFF.

NOTE: If IR filter mode is changed to Auto, the Shutter Speed setting will return to Auto.

Off – IR filter is manually operated. The following presets are used to manually operate the IR filter.

Preset 88 – Filter IN (color)

Preset 89 – Filter OUT (monochrome)

To change the IR filter mode:

1. Program preset 95 (28). The main menu appears.
2. Position the cursor (>) beside Camera.
3. Press the Iris Open button to enter the Camera menu.
4. Position the cursor (>) beside Next.
5. Press the Iris Open button to enter the Next menu.
6. Position the cursor (>) beside IR Filter.
7. Press the Iris Open button to enter the IR Filter menu.
8. Position the cursor (>) beside IR Filter Mode.
9. Press the Iris Open button. The cursor moves to the right, beside the word Auto or Off.
10. Move the joystick up or down to toggle between Auto and Off.
11. SELECT – Press the Iris Open button on your keyboard to select your choice.
CANCEL – Press the Iris Close button if you do not want to change the setting.

LIMIT STOPS

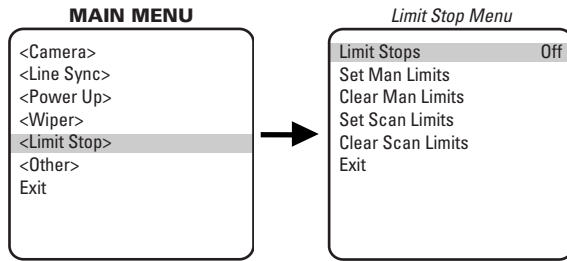

NOTE: Limit stops are inactive while setting items in the program menu (e.g. azimuth zero, scan limits, manual pan limits).

TURNING LIMIT STOPS ON OR OFF

To change the limit stop mode:

1. Program preset 95 (28). The main menu appears.
2. Position the cursor (>) beside Limit Stop.
3. Press the Iris Open button to enter the Limit Stop menu.
4. Position the cursor (>) beside Limit Stops.
5. Press the Iris Open button. The cursor moves to the right, beside the word On or Off.
6. Move the joystick up or down to toggle between On and Off.
7. SELECT – Press the Iris Open button on your keyboard to select your choice.
CANCEL – Press the Iris Close button if you do not want to change the setting.

PROGRAMMING LIMIT STOPS

Manual Limit Stops

When manual limit stops are set, a (joystick/pan and tilt keys) pan operation stops when a limit stop is reached. The manual limit stops can be set in one of two ways:

At the controller by programming presets 90 (23) and 91 (24)

or

At the controller by programming the Limit Stops menu

PRESETS

Refer to the documentation for your control system for programming presets, and then do the following:

1. Make sure limit stops are turned ON, then exit the menu.
2. Push the joystick left until you reach the limit you want the camera to go to on the left.
3. Program preset 90 (23).
4. Push the joystick right to the limit you want the camera to go to on the right.
5. Program preset 91 (24).

Setting presets 90 (23) and 91 (24) to the same point disables manual limit stops.

NOTE: Programming preset 90 (23) disables the manual limit stops until preset 91 (24) is set. Preset 90 (23) is the left manual limit and preset 91 (24) is the right manual limit.

LIMIT STOPS MENU

The manual pan limit stops can be set at the controller using the Limit Stops menu:

1. Program preset 95 (28). The main menu appears.
2. Position the cursor (>) beside Limit Stop.
3. Press the Iris Open button to enter the Limit Stop menu.
4. Move the cursor to Set Man Limits and press the Iris Open button. PRESS IRIS OPEN TO SET LEFT LIMIT appears.
5. Move the pan and tilt to the desired left limit position and press the Iris Open button to set the left manual limit. PRESS IRIS OPEN TO SET RIGHT LIMIT appears.
6. Move the pan and tilt to the desired right limit position and press the Iris Open button to set the right manual limit.
7. Exit the Limit Stop menu.

CLEAR MANUAL STOPS

To clear the manual limit stops:

1. Program preset 95 (28). The main menu appears.
2. Position the cursor (>) beside Limit Stop.
3. Press the Iris Open button to enter the Limit Stop menu.
4. Move the cursor to Clear Man Limits and press the Iris Open button. The cursor will flash to an asterisk (*) briefly to indicate the limits have been disabled.

Scan Limit Stops

When scan limit stops are set, the pan and tilt reverses direction during random, frame, or auto scanning when a limit stop is reached. The manual scan limit stops can be set in one of two ways:

At the controller by programming presets 92 and 93

or

At the controller by programming the Limit Stops menu

PRESETS

Refer to the documentation for your control system for programming presets, and then do the following:

1. Make sure limit stops are turned ON, then exit the menu.
2. Push the joystick left until you reach the limit you want the camera to go to on the left.
3. Program preset 92 (25).
4. Push the joystick right to the limit you want the camera to go to on the right.
5. Program preset 93 (26).

Setting presets 92 (25) and 93 (26) to the same point disables manual limit stops.

NOTE: Programming preset 92 (25) disables the scan limit stops until preset 93 (26) is set. Preset 92 is the left scan limit and preset 93 is the right scan limit.

LIMIT STOPS MENU

The manual pan limit stops can be set at the controller using the Limit Stops menu:

1. Program preset 95 (28). The main menu appears.
2. Position the cursor (>) beside Limit Stop.
3. Press the Iris Open button to enter the Limit Stop menu.
4. Move the cursor to Set Scan Limits and press the Iris Open button. PRESS IRIS OPEN TO SET LEFT LIMIT appears.
5. Move the pan and tilt to the desired left limit position and press the Iris Open button to set the left manual limit. PRESS IRIS OPEN TO SET RIGHT LIMIT appears.
6. Move the pan and tilt to the desired right limit position and press the Iris Open button to set the right scan limit.
7. Exit the Limit Stop menu.

CLEAR SCAN LIMIT STOPS

To clear the scan limit stops, move the cursor to Clear Scan Limits and press the Iris Open button. The cursor will flash to an asterisk (*) briefly to indicate the limits have been disabled.

LINE SYNCHRONIZATION

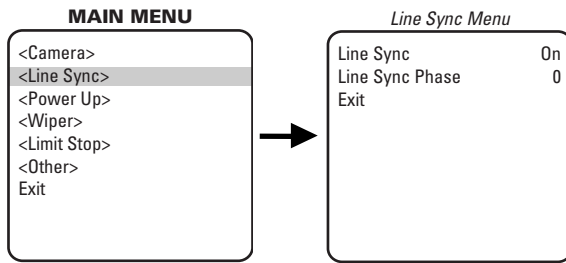

If cameras are out of phase with each other, they may produce what appears to be vertical roll when switching between cameras.

There are two settings for line synchronization:

- On – Adjust the synchronization of the power line voltage so that it is in phase with other cameras.
- Off – The system synchronizes to an internal clock.

To change the line synchronization settings:

1. Program preset 95 (28). The main menu appears.
2. Position the cursor (>) beside Line Sync.
3. Press the Iris Open button. The Line Sync menu appears.
4. Position the cursor (>) beside one of the choices. Press the Iris Open button.

LINE SYNC – The cursor moves to one of two choices: on or off. Move the joystick up or down to toggle between them. Press the Iris Open button to select the choice. If you changed to off, the camera may reset itself as it adjusts to the new synchronization. If the camera resets, it will only affect the line synchronization. It will not change any other camera parameters, such as auto focus or auto iris. Press the Iris Close button if you do not want to change the setting.

LINE SYNC PHASE – The cursor moves to a numeric value. Move the joystick up or down to change the value. The value represents the phase angle in tenths of a degree between 0 and 359 degrees. For example, 900 is 90 degrees, 1200 is 120 degrees, and 2400 is 240 degrees. Press the Iris Open button on your keyboard to select your choice. The Line Sync setting changes to ON. The camera may reset or the picture on your monitor may wiggle when you change the phase angle. If the camera resets, it will only affect the line synchronization. It will not change any other camera parameters, such as auto focus or auto iris. Press the Iris Close button if you do not want to change the setting.

LOWLIGHT LIMIT (MODELS ES30C22/ES31C22 AND ES30CBW18/ES31CBW18 ONLY)

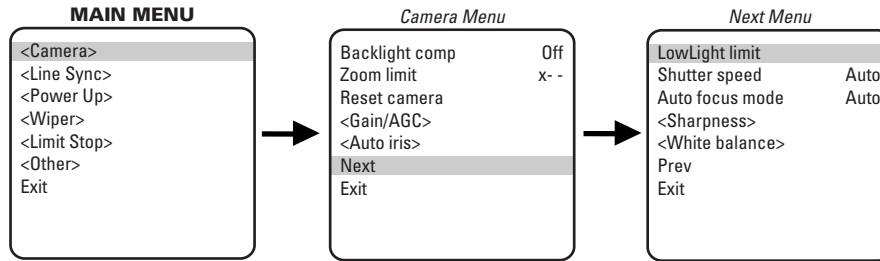

This setting determines the maximum length of time the shutter will remain open automatically in low light conditions. There are six choices:

2 = 1/2 second 8 = 1/8 second 30 = 1/30 second
4 = 1/4 second 15 = 1/15 second 60 = 1/60 second

NOTE: LOWLIGHT does not mean NO LIGHT. Some type of illumination is required.

NOTE: Auto focus is automatically turned off when the shutter speed is longer than 1/8 of a second.

To change the LowLight setting:

1. On the main menu, move the joystick up or down to position the cursor (>) beside Camera.
2. Press the Iris Open button to enter the Camera menu.
3. Position the cursor (>) beside Next.
4. Press the Iris Open button to go to the Next (camera) menu.
5. Position the cursor (>) beside LowLight Limit.
6. Press the Iris Open button. The cursor moves to the right, beside the current LowLight Limit.
7. Move the joystick up or down to choose the LowLight Limit.
8. **SELECT** – Press the Iris Open button to select your choice.
CANCEL – Press the Iris Close button if you do not want to change the setting.

PARK TIME MINUTES

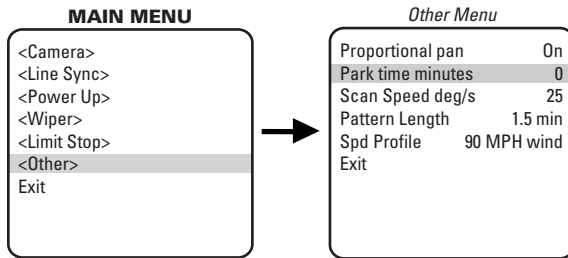

This feature causes the system to park at preset 1 after a programmed number of minutes of control inactivity. The time can be set from 1 minute to 720 minutes (12 hours), or it can be set to zero, which disables this feature.

NOTE: Preset 1 must be programmed for the dome to park.

To change the park time:

1. Program preset 95 (28). The main menu appears.
2. Position the cursor (>) beside Other.
3. Press the Iris Open button to enter the Other menu.
4. Position the cursor (>) beside Park Time Minutes.
5. Press the Iris Open button. The cursor moves to the right, beside the current park time.
6. Move the joystick up or down to change the park time.
7. SELECT – Press the Iris Open button on your keyboard to select your choice.
CANCEL – Press the Iris Close button if you do not want to change the setting.

PATTERN LENGTH

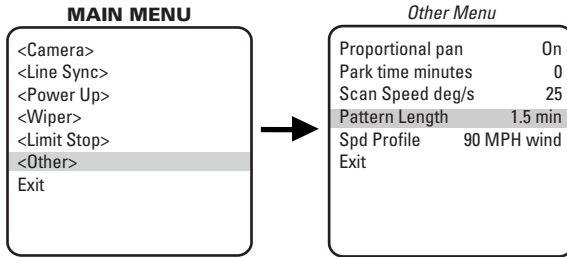

The Esprit can do the following:

- One full pattern - 1.5, 3, or 6 minutes long
- or
- Two half patterns - .75, 1.5, or 3 minutes long

This pattern can consist of any standard pan, tilt, or lens command. Presets, flip, and turbo are not allowed in a pattern. Zone scan can be enabled while running a pattern.

NOTE: Digital zoom and proportional pan are not available during a pattern.

To set the pattern length:

1. Program preset 95 (28). The main menu appears.
2. Position the cursor (>) beside Other.
3. Press the Iris Open button to enter the menu entitled Other.
4. Position the cursor (>) beside Pattern Length.
5. Press the Iris Open button. The cursor moves to the right, beside the number of minutes (1.5, 3, or 6).
6. Move the joystick up or down to toggle through the number of minutes (1.5, 3, or 6).



CAUTION: If the pattern length is changed, all patterns that were stored are erased.

7. SELECT – Press the Iris Open button on your keyboard to select your choice.
CANCEL – Press the Iris Close button if you do not want to change the setting.

POWER-UP MODE

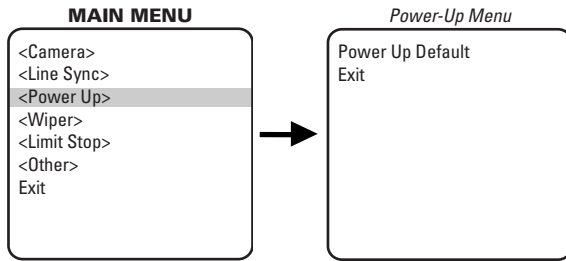

This feature lets the dome resume a desired condition following power-up. The menu includes the following choices.

- **Default** – On power-up, the system goes through a configuration cycle and stops at zero reference, showing “Configuration Done,” address, and mode settings on the screen.
- **Park** – The system moves to preset 1 when the power-up sequence finishes. The only text on the screen is the preset label (if any is programmed).
- **Scan Auto** – The system initiates scan mode when the power-up sequence finishes. Again, there is no text.
- **Scan Frame** – The system initiates a frame scan when the power-up sequence finishes.
- **Scan Rand** – The system initiates a random scan when the power-up sequence finishes.
- **Full Pat** – The system initiates its programmed pattern when the power-up sequence finishes. The length can be set to 1.5, 3, or 6 minutes.
- **Half Pat 1** – The system initiates the first half-pattern when the power-up sequence finishes. The length can be set to .75, 1.5, or 3 minutes.
- **Half Pat 2** – The system initiates the second half-pattern when the power-up sequence finishes. The length can be set to .75, 1.5, or 3 minutes.

The default setting is Default.

To select the power-up mode:

1. Program preset 95 (28). The main menu appears.
2. Position the cursor (>) beside Power Up.
3. Press the Iris Open button to enter the Power-Up menu.
4. Press the Iris Open button to move the cursor to the right.
5. Move the joystick up or down to cycle through the selections. Stop on the item you want to select.
6. **SELECT** – Press the Iris Open button on your keyboard to select your choice.
CANCEL – Press the Iris Close button if you do not want to change the setting.

PROPORTIONAL PAN

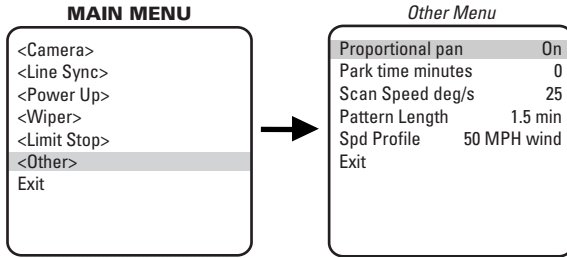

There are two proportional pan modes:

On – Enables the proportional pan mode. The amount of zoom controls the pan and tilt. At telephoto zoom settings, the pan and tilt speeds will be slower for a given amount of joystick deflection than at wide zoom settings. This keeps the image from moving too fast on the monitor when there is a large amount of zoom.

Off – Disables proportional pan mode. The pan speed will not depend on the amount of zoom.

NOTE: Proportional pan is not available during a pattern.

To change the proportional pan mode:

1. Program preset 95 (28). The main menu appears.
2. Position the cursor (>) beside Other.
3. Press the Iris Open button to enter the Other menu.
4. Position the cursor (>) beside Proportional Pan.
5. Press the Iris Open button. The cursor moves to the right, beside the word On or Off.
6. Move the joystick up or down to toggle between On and Off.
7. **SELECT** – Press the Iris Open button on your keyboard to select your choice.
CANCEL – Press the Iris Close button if you do not want to change the setting.

RESET CAMERA

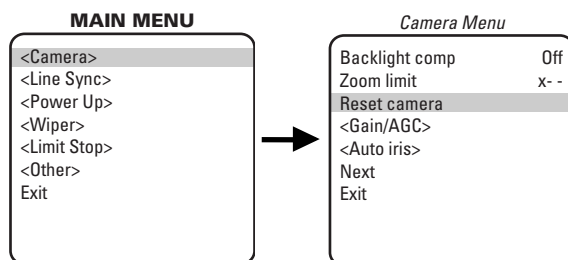

Resetting the camera returns the settings to their defaults.

	Models ES30C22/ES31C22	Models ES30CBW18/ES31CBW18	Models ES30C16/ES31C16
Default Setting	Backlight comp	Off	Off
	Zoom Limit	No default	No default
	Gain/AGC Gain Limit	27	<u>NTSC</u> 28 <u>PAL</u> 29
	Auto iris Mode	Auto	Auto
	Level	66	91
	Peak	16	16
	Low light limit	2	2
	Shutter speed	Auto	Auto
	Auto focus mode	Auto	Auto
	IR Filter IR filter mode	N/A	Auto
	Auto IR level	N/A	Dusk
	Sharpness Auto sharpness	On	On
Sharpness	No default	No default	
White balance Auto white bal	On	On	
R Gain	No default	No default	
B Gain	No default	No default	

Turning off power does not reset the camera. Camera settings are retained in memory. When the power is turned back on, the settings will be the same as they were when the power was turned off.

To reset the camera:

1. Program preset 95 (28). The main menu appears.
2. Position the cursor (>) beside Camera.
3. Press the Iris Open button to enter the Camera menu.
4. Position the cursor (>) beside Reset Camera.
5. Press the Iris Open button to reset the camera.

SCAN SPEED

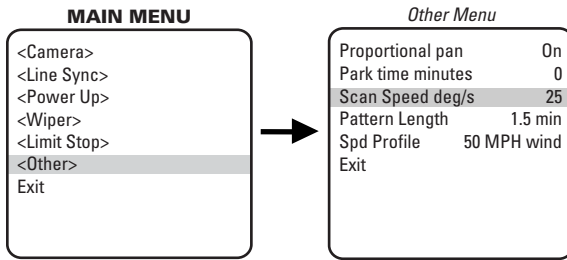

The scan speed is adjustable from 1-40 degrees per second. This occurs in three scan modes: auto, random, and frame scan.

To change the scan speed:

1. Program preset 95 (28). The main menu appears.
2. Position the cursor (>) beside Other.
3. Press the Iris Open button to enter the menu entitled Other.
4. Position the cursor (>) beside Scan Speed deg/s.
5. Press the Iris Open button. The cursor moves to the right, beside the number of degrees.
6. Move the joystick up or down to toggle through the number of degrees (1-40) until you reach the number you want. (If set on a low number, the scan will appear to barely move but is still functioning.)
7. **SELECT** – Press the Iris Open button on your keyboard to select your choice.
CANCEL – Press the Iris Close button if you do not want to change the setting.

SHARPNESS

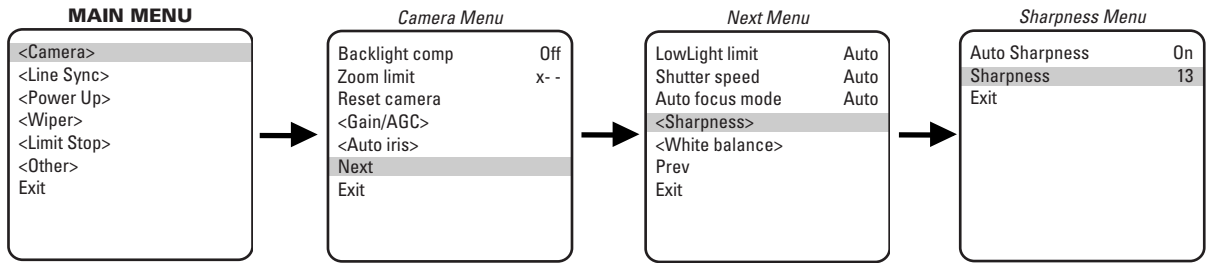

Use the Sharpness setting to manually set the sharpness of the camera.

To manually set the sharpness of the camera:

1. Program preset 95 (28). The main menu appears.
2. Position the cursor (>) beside Camera.
3. Press the Iris Open button to enter the Camera menu.
4. Position the cursor (>) beside Next. Press the Iris Open button.
5. Position the cursor (>) beside Sharpness. Press the Iris Open button.
6. Position the cursor (>) beside Sharpness. Press the Iris Open button the cursor moves to the right, beside the numeric value.
7. Move the joystick up or down to a value. As you change the value, you will see the sharpness change. Press the Iris Open button to select the value, or press the Iris Close button if you do not want to change the setting. If the Auto Sharpness setting is On, it will change to Off when you select a Sharpness value.

SHUTTER SPEED

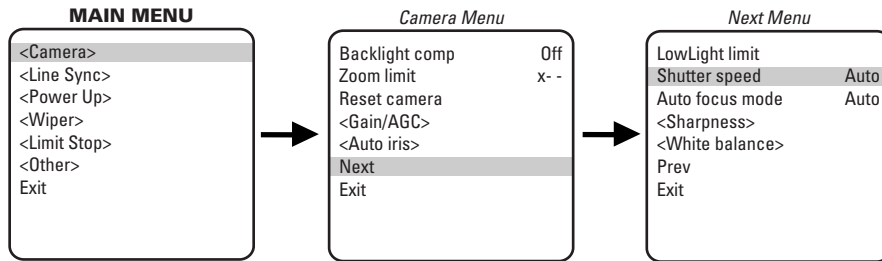

There are several electronic shutter speed settings:

Auto
1/2
1/4
1/8
1/15
1/30
1/60
1/120
1/180
1/250
1/500
1/1000
1/2000
1/4000
1/10,000
1/30,000

In the Auto setting the camera controls the shutter speed automatically. Increasing the shutter speed lowers the light sensitivity, but rapidly moving objects will be less blurred.

NOTE: (ES30PCBW18/ES31PCBW18) If the IR Filter Mode is set to Auto, the Shutter Speed setting will default automatically to the Auto setting.

To change the electronic shutter speed settings:

1. Program preset 95 (28). The main menu appears.
2. Position the cursor (>) beside Camera.
3. Press the Iris Open button to enter the Camera menu.
4. Position the cursor (>) beside Next.
5. Press the Iris Open button to go to the Next menu.
6. Position the cursor (>) beside Shutter Speed.
7. Press the Iris Open button.
8. The cursor moves to the right, beside the current shutter speed.
9. Move the joystick up or down to choose the shutter speed.
10. **SELECT** – Press the Iris Open button on your keyboard to select your choice.
CANCEL – Press the Iris Close button if you do not want to change the setting.

SPEED PROFILE

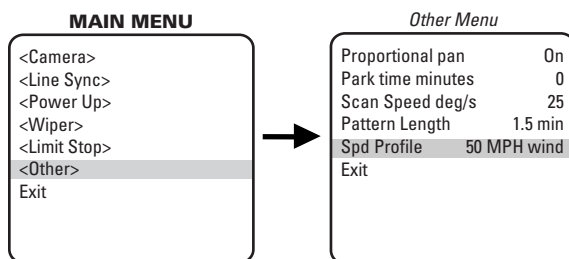

This feature allows the operator to set the wind speed conditions for the location of the Esprit system. You can set two wind speed profiles of 50 mph or 90 mph in which the system will remain operational. In both settings, the pan speed will be a maximum of 40 degrees per second. The difference will be in the turbo and preset pan speeds. The turbo and preset pan speeds are 100 degrees per second in the 50 mph wind profile setting and 50 degrees per second in the 90 mph profile.

To set the speed profile:

1. Program preset 95 (28). The main menu appears.
2. Position the cursor (>) beside Other.
3. Press the Iris Open button to enter the menu entitled Other.
4. Position the cursor (>) beside Spd Profile.
5. Press the Iris Open button. The cursor moves to the right, beside the wind speed (50 mph wind or 90 mph wind).
6. Move the joystick up or down to toggle through the wind speeds (50 mph wind or 90 mph wind).
7. **SELECT** – Press the Iris Open button on your keyboard to select your choice.
CANCEL – Press the Iris Close button if you do not want to change the setting.

WHITE BALANCE

The settings for white balance are as follows:

Auto white bal
R Gain
B Gain

To change the white balance settings:

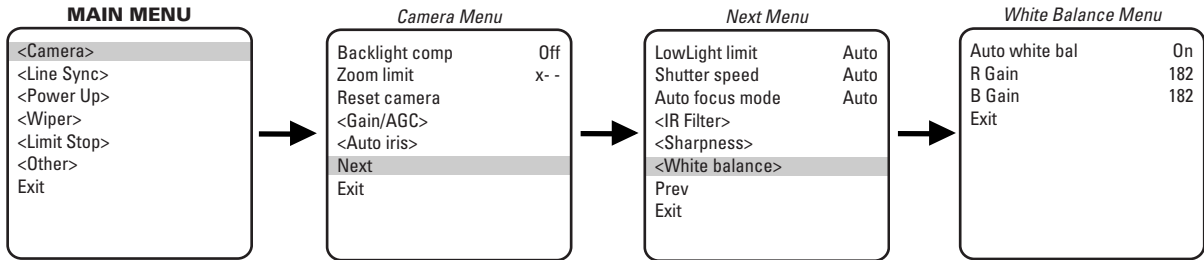

1. Program preset 95 (28). The main menu appears.
2. Position the cursor (>) beside Camera.
3. Press the Iris Open button to enter the Camera menu.
4. Position the cursor (>) beside Next.
5. Press the Iris Open button to go to the Next menu.
6. Position the cursor (>) beside White Balance.
7. Press the Iris Open button. The White Balance menu appears.
8. Position the cursor (>) beside one of the following choices and press the Iris Open button.
8. Move the joystick up or down to make a selection.
9. SELECT – Press the Iris Open button on your keyboard to select your choice.
CANCEL – Press the Iris Close button if you do not want to change the setting.

WIPER MODE

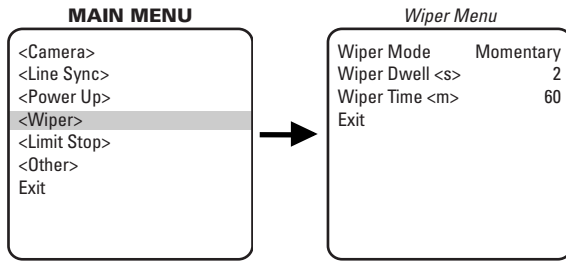

There are three wiper settings:

Wiper Mode
Wiper Dwell
Wiper Time

To change the wiper settings:

1. Program preset 95 (28). The main menu appears.
2. Position the cursor (>) beside Wiper.
3. Press the Iris Open button to enter the Wiper menu.
4. Move the joystick up or down to position the cursor next to one of the wiper settings.
5. Press the Iris Open button. The cursor moves to the right.
6. Move the joystick up or down to toggle through the choices.
7. SELECT – Press the Iris Open button on your keyboard to select your choice.
CANCEL – Press the Iris Close button if you do not want to change the setting.

To operate the wiper, do the following:

Momentary Mode – To operate the wiper one full cycle, press the AUX 1 button on your controller. Each press of the button operates the wiper one full cycle, even if the AUX 1 button is latching. If AUX 1 is latching, the first press will activate the wiper (open the latch). Pressing AUX 1 a second time closes the latch, but will not cycle the wiper. Press the AUX 1 key again to cycle the wiper.

Continuous Mode – To operate the wiper press the AUX 1 button on your controller. The wiper will continue to operate until the AUX 1 button is pressed again or until the programmed cycle is completed.

NOTE: CM9740 and CM9760 Matrix Systems Only – For the wiper to operate in continuous mode, the AUX 1 function in the camera file must be set to latching. If the AUX 1 camera file is not latching, the wiper will only operate in momentary mode, even if the Esprit wiper is programmed for continuous operation. Refer to the operation manual supplied with the CM9740 or CM9760 matrix system for instructions.

Wiper Dwell – The time between wiper cycles. The dwell time can be programmed from 2 to 30 seconds.

Wiper Time – The length of the wiper cycle. Wiper time can be programmed from 60 to 1,440 minutes (1 to 24 hours).

ZONE BLANK

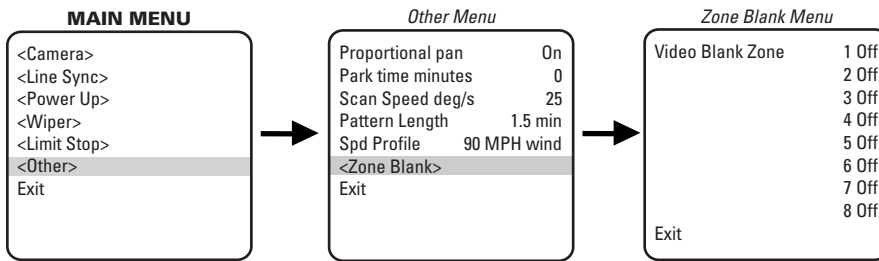

The Esprit system features onscreen programmable zone blanking. This feature lets you define any zone as blanked for video (viewing/recording).

Zones can be programmed to overlap each other, although this is not recommended. If you program two zones to overlap, the title of the zone with the highest priority (zone 8 is the highest, zone 1 is the lowest) will be displayed on the monitor. This rule also applies to blanked zones that overlap. The blanking status of the zone with the highest priority will determine if the area is blanked or not. Example: Zone 1 is blanked but a portion of the zone overlaps zone 8 which is not blanked. The overlapped portion of zone 1 will be displayed on the monitor with the zone 8 label.

There are two video zone blank settings:

- On – Enables video blanking.
- Off – Disables video blanking.

To change the video blank zone setting:

1. Program preset 95 (28). The main menu appears.
2. Position the cursor (>) beside Other.
3. Press the Iris Open button to enter the Other menu.
4. Position the cursor (>) beside Zone Blank.
5. Press the Iris Open button to enter the Zone Blank menu.
6. Position the cursor (>) beside the number of the zone for which you want to set the blank option.
7. Press the Iris Open button. The cursor moves to the right, beside the word On or Off.
8. Move the joystick up or down to toggle between the words On and Off.
9. SELECT – Press the Iris Open button on your keyboard to select your choice.
CANCEL – Press the Iris Close button if you do not want to change the setting.

ZONES

Basic rules for setting zones:

1. Refer to the documentation for your control system to program zones.
2. Establish zones using the controller, prior to programming ZONE BLANK with the Esprit onscreen menu.
3. To accurately set zone areas, zoom wide to the maximum field of view.
4. Set zones moving the joystick left to right. The left position is always the start position.

ZOOM

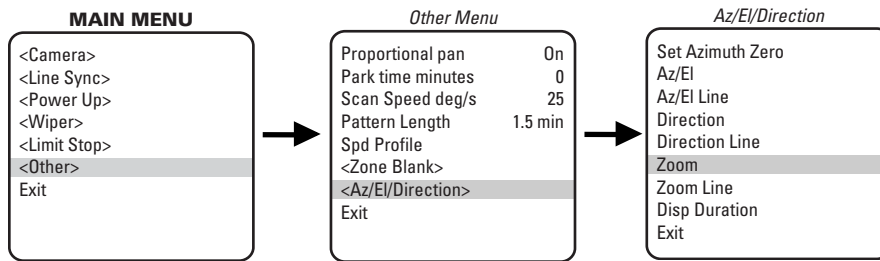

Zoom programs the horizontal display position of the Zoom label. The following settings are available for the Zoom label:

- Off – Label is not displayed.
- Left – Label is displayed on the left-hand side of the screen.
- Center (default) – Label is displayed in the center of the screen.
- Right – Label is displayed on the right-hand side of the screen.

NOTE: Zoom display is not available while you are programming or running a pattern.

To program the horizontal label position for Zoom:

1. Program preset 95 (28). The main menu appears.
2. Position the cursor (>) beside Other.
3. Press the Iris Open button to enter the Other menu.
4. Position the cursor (>) beside Az/EI/Direction.
5. Press the Iris Open button to enter the Az/EI/Direction menu.
6. Position the cursor (>) beside Zoom.
7. Press the Iris Open button. The cursor moves to the right.
8. Move the joystick up or down to view the available selections.
9. SELECT – Press the Iris Open button to make a selection.
CANCEL – Press the Iris Close button to cancel a selection.

ZOOM LIMIT

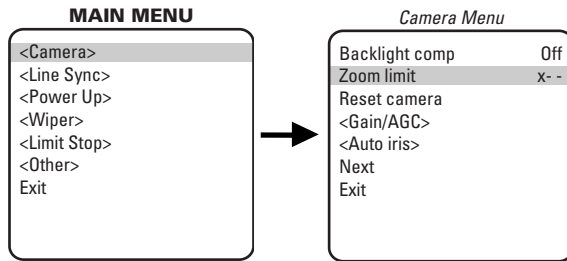

ES30C16/ES31C16 - 16X optical zoom and 10X electronic zoom, can be set for 16X, 32X, 64X, 128X, or 160X.

ES30C22/ES31C22 - 22X optical zoom and 10X electronic zoom, can be set for 22X, 32X, 88X, 176X, or 220X.

ES30CBW18/ES31CBW18 - 23X optical zoom and 10X electronic zoom, can be set for 23X, 32X, 92X, 184X or 230X.

To change the zoom limit:

1. Program preset 95 (28). The main menu appears.
2. Position the cursor (>) beside Camera.
3. Press the Iris Open button to enter the Camera menu.
4. Position the cursor (>) beside Zoom Limit.
5. Press the Iris Open button. The cursor moves to the right, beside the current zoom limit.
6. Move the joystick up or down to choose the zoom limit.
7. SELECT – Press the Iris Open button on your keyboard to select your choice.
CANCEL – Press the Iris Close button if you do not want to change the setting.

ZOOM LINE

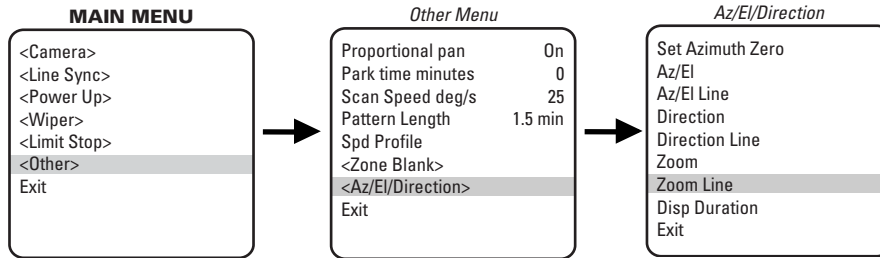

Zoom Line controls the vertical display position of the Zoom label. The label may be displayed on lines 3 through 10. Line 3 is the third line from the top of the screen and line 10 is located at the bottom of the screen. Line 10 is the default setting.

NOTE: Zoom display is not available while you are programming or running a pattern.

To program the vertical label position for Zoom:

1. Program preset 95 (28). The main menu appears.
2. Position the cursor (>) beside Other.
3. Press the Iris Open button to enter the Other menu.
4. Position the cursor (>) beside Az/EI/Direction .
5. Press the Iris Open button to enter the Az/EI/Direction menu.
6. Position the cursor (>) beside Zoom Line.
7. Press the Iris Open button. The cursor moves to the right.
8. Move the joystick up or down to view the available selections.
9. SELECT – Press the Iris Open button to make a selection.
CANCEL – Press the Iris Close button to cancel selection.

SPECIFICATIONS

ELECTRICAL

Input Voltage:	24, 120, or 230 VAC, 50/60 Hz; switch selectable for 120/230 VAC inputs. Reset feature enabled when power becomes unstable or interrupted.
Power Requirements:	Maximum power consumption is 70 VA per system
Heater and Defroster:	Thermostatically controlled heater consumes 10 watts and cycles on at 40°F (5°C) and off at 60°F (16°C)
Defogger:	The window defogger consumes 3 watts and cycles on at 70°F (21°C) and off at 85°F (29°C)
Electrical Connections:	Two power source connections made at mount location with wire splices and one ground wire splice; one BNC receptacle and four wire splices at mount location for RS-422 D and P protocols; two wire splices for open collector auxiliary output
Aux 2:	Open collector output with 2-second activation; connected relay must require no more than 32 VDC and 40 mA to energize relay coil; wire length between Esprit and relay must be less than 100 ft (30 m)

MECHANICAL

Construction	
System:	Die-cast, extruded and sheet aluminum; stainless steel hardware
EWM Wall Mount:	Aluminum
EPA Pedestal Adapter:	Aluminum
Finish	
System:	Gray polyester powder coat, anodized
EWM Wall Mount:	Gray polyester powder coat
EPA Pedestal Adapter:	Gray polyester powder coat
Viewing Window:	0.23-inch (5.84 mm) thick, optically clear, polycarbonate with proprietary impact resistant UV rated coating
Window Viewing Area:	2-inch (5 cm) diameter

CAMERAS

Scanning System	
ES30C16/ES31C16 and ES30C22/ES31C22:	2:1 interlace
ES30CBW18/ES31CBW18:	2:1 interlace
Image Sensor:	1/4-inch
Effective Pixels	
ES30C16/ES31C16 NTSC:	768 (H) x 494 (V)
ES30C16/ES31C16 PAL:	752 (H) x 582 (V)
ES30C22/ES31C22 NTSC:	768 (H) x 494 (V)
ES30C22/ES31C22 PAL:	752 (H) x 582 (V)
ES30CBW18/ES31CBW18 NTSC:	724 (H) x 494 (V)
ES30CBW18/ES31CBW18 PAL:	724 (H) x 582 (V)
Horizontal Resolution	
ES30C16/ES31C16:	>470 TV lines (NTSC) >460 TV lines (PAL)
ES30C22/ES31C22:	>470 TV lines (NTSC) >460 TV lines (PAL)
ES30CBW18/ES31CBW18:	>470 TV lines (NTSC) >470 TV lines (PAL)
Focal Length	
ES30C16/ES31C16:	4 mm to 64 mm optical
ES30C22/ES31C22:	4 mm to 88 mm optical
ES30CBW18/ES31CBW18:	3.6 mm to 82.8 mm optical
Zoom Ratio	
ES30C16/ES31C16:	16X optical zoom, 10X electronic zoom
ES30C22/ES31C22:	22X optical zoom, 10X electronic zoom
ES30CBW18/ES31CBW18:	23X optical zoom, 10X electronic zoom
Digital Slow Shutter:	Auto/manual speed selection
Horizontal Angle of View	
ES30C16/ES31C16:	43° at 4 mm wide zoom; 3° at 64 mm telephoto zoom
ES30C22/ES31C22:	47° at 4 mm wide zoom; 2° at 88 mm telephoto zoom
ES30CBW18/ES31CBW18:	54° at 3.6 mm wide zoom; 2.5° at 82.8 mm telephoto zoom
Focus:	Automatic and manual override

Sensitivity	
ES30C16/ES31C16:	0.05 lux at 1/2-second shutter speed (NTSC) 0.05 lux at 1/1.5-second shutter speed (PAL)
ES30C22/ES31C22:	0.02 lux at 1/2-second shutter speed (NTSC) 0.02 lux at 1/1.5-second shutter speed (PAL)
ES30CBW18/ES31CBW18:	0.08 lux at 1/2-second shutter speed (color, NTSC/PAL) 0.3 lux at 1/1.5-second shutter speed (B-W, NTSC/PAL) 0.013 lux at 1/2-second shutter speed (B-W, NTSC/PAL)
Synchronization System:	AC line lock, phase adjustable via remote control*
White Balance:	Automatic with manual override*
Shutter Speed:	1/2 to 1/30,000 (NTSC) 1/1.5 to 1/30,000 (PAL)
Iris Control:	Automatic with manual override*
Gain Control	
ES30C16/ES31C16:	Automatic with manual override*
ES30C22/ES31C22:	Automatic/OFF*
ES30CBW18/ES31CBW18:	Automatic/OFF*
Video Output:	1 Vp-p, 75 ohms
Signal to Noise Ratio	
ES30C16/ES31C16:	46 dB
ES30C22/ES31C22:	50 dB
ES30CBW18/ES31CBW18:	50 dB
Construction:	Die-cast, extruded, and sheet aluminum; stainless steel hardware
Finish:	Gray polyester powder coat
Viewing Window:	0.23-inch (5.84 mm) thick, optically clear, impact/scratch-resistant coated LEXAN,
Operating Temperature:	-50° to 122°F (-45° to 50°C) for sustained system operation or 140°F (60°C) absolute maximum. Within 2 hours after power-up, the entire unit can de-ice and be operational from a temperature of 13°F (-25°C).
Operating Environment:	Will remain operational in 90 mph wind conditions; withstands 130 mph.
Weight	With Pedestal Adapter With Wall Mount
Unit	
Standard w/IOP:	20 lb (9.0 kg) 22 lb (9.9 kg)
With Wiper and IOP:	21 lb (9.5 kg) 23 lb (10.4 kg)
Ratings:	Meets NEMA Type 4X and IP66 standards

* Manual control of camera setup functions can be done with CM6700, CM6800, CM8500, CM9500, CM9740, CM9760, CM9770, KBD200A, KBD300A, and MPT9500 controllers, but not with CM7500, MPT9000, or KBD9000 controllers.

(Design and product specifications subject to change without notice.)

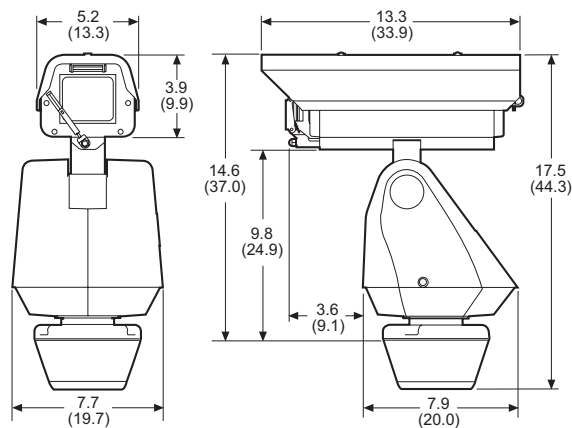

NOTE: VALUES IN PARENTHESES ARE CENTIMETERS;
ALL OTHERS ARE IN INCHES.

REGULATORY NOTICES

This equipment has been tested and found to comply with the limits of a Class A digital device, pursuant to part 15 of the FCC rules. These limits are designed to provide reasonable protection against harmful interference when the equipment is operated in a commercial environment. This equipment generates, uses, and can radiate radio frequency energy and, if not installed and used in accordance with the instruction manual, may cause harmful interference to radio communications. Operation of this equipment in a residential area is likely to cause harmful interference in which case the user will be required to correct the interference at his own expense.

WARRANTY AND RETURN INFORMATION

WARRANTY

Pelco will repair or replace, without charge, any merchandise proved defective in material or workmanship for a period of one year after the date of shipment.

Exceptions to this warranty are as noted below:

- Five years on FT/FR8000 Series fiber optic products and the following fixed camera models: CC3701H-2, CC3701H-2X, CC3751H-2, CC3651H-2X, MC3651H-2, and CC3651H-2X.
- Three years on all other fixed camera models (including Camclosure Integrated Camera Systems) and Genex Series (multiplexers, server, and keyboard).
- Two years on all standard motorized or fixed focal length lenses.
- Two years on Legacy, CM6700/CM6800/CM8500/CM9500/CM9700 Series Matrix, DF5 and DF8 Series Fixed Dome products.
- Two years on Spectra, Esprit, and PS20 Scanners, including when used in continuous motion applications.
- Two years on Esprit and WW5700 Series window wiper (excluding wiper blades).
- Eighteen months on DX Series digital video recorders and NVR300 network video recorders.
- One year (except video heads) on video cassette recorders (VCRs). Video heads will be covered for a period of six months.
- Six months on all pan and tilts, scanners or preset lenses used in continuous motion applications (that is, preset scan, tour and auto scan modes).

Pelco will warrant all replacement parts and repairs for 90 days from the date of Pelco shipment. All goods requiring warranty repair shall be sent freight prepaid to Pelco, Clovis, California. Repairs made necessary by reason of misuse, alteration, normal wear, or accident are not covered under this warranty.

Pelco assumes no risk and shall be subject to no liability for damages or loss resulting from the specific use or application made of the Products. Pelco's liability for any claim, whether based on breach of contract, negligence, infringement of any rights of any party or product liability, relating to the Products shall not exceed the price paid by the Dealer to Pelco for such Products. In no event will Pelco be liable for any special, incidental or consequential damages (including loss of use, loss of profit and claims of third parties) however caused, whether by the negligence of Pelco or otherwise.

The above warranty provides the Dealer with specific legal rights. The Dealer may also have additional rights, which are subject to variation from state to state.

If a warranty repair is required, the Dealer must contact Pelco at (800) 289-9100 or (559) 292-1981 to obtain a Repair Authorization number (RA), and provide the following information:

1. Model and serial number
2. Date of shipment, P.O. number, Sales Order number, or Pelco invoice number
3. Details of the defect or problem

If there is a dispute regarding the warranty of a product which does not fall under the warranty conditions stated above, please include a written explanation with the product when returned.

Method of return shipment shall be the same or equal to the method by which the item was received by Pelco.

RETURNS

In order to expedite parts returned to the factory for repair or credit, please call the factory at (800) 289-9100 or (559) 292-1981 to obtain an authorization number (CA number if returned for credit, and RA number if returned for repair).

All merchandise returned for credit may be subject to a 20% restocking and refurbishing charge.

Goods returned for repair or credit should be clearly identified with the assigned CA or RA number and freight should be prepaid. Ship to the appropriate address below.

If you are located within the continental U.S., Alaska, Hawaii or Puerto Rico, send goods to:

Service Department
Pelco
3500 Pelco Way
Clovis, CA 93612-5699

If you are located outside the continental U.S., Alaska, Hawaii or Puerto Rico and are instructed to return goods to the USA, you may do one of the following:

If the goods are to be sent by a COURIER SERVICE, send the goods to:

Pelco
3500 Pelco Way
Clovis, CA 93612-5699 USA

If the goods are to be sent by a FREIGHT FORWARDER, send the goods to:

Pelco c/o Expeditors
473 Eccles Avenue
South San Francisco, CA 94080 USA
Phone: 650-737-1700
Fax: 650-737-0933

REVISION HISTORY

Manual #	Date	Comments
C309M	9/00	Original version.
C309M-A	12/00	Added information on "Pan Limit" message per ECO #00-6635.
C309M-B	6/01	Added information on zone blanking.
C309M-C	9/02	Camera modifications.
C309M-D	6/03	Added Az/El/Direction menu per ECO #03-8861. Updated layout.
C309M-E	8/03	Revised per ECO #03-9210 for new camera design.
C309M-F	9/03	Revised Preset Functions description on page 14.
C309M-G	10/03	Revised per ECO #03-9238. Updated to match spec sheet.
C309M-H	2/04	Revised the signal to noise ratio for the ES30C22/ES31C22.
C309M-I	6/04	Updated manual for software release v3.18 per ECO #04-9694.
C309M-J	9/04	Updated manual for software release v3.23 per ECO #04-10248.



Worldwide Headquarters
3500 Pelco Way
Clovis, California 93612 USA

USA & Canada
Tel: 800/289-9100
Fax: 800/289-9150

International
Tel: 1-559/292-1981
Fax: 1-559/348-1120

www.pelco.com

ISO9001

United States | Canada | United Kingdom | The Netherlands | Singapore | Spain | Scandinavia | France | Middle East